

BOOK'16

HEATING PRODUCTS DESIGNED
AND DEVELOPED BY FOURSTEEL®

FOURSTEEL®

[heating products factory]

FOURSTEEL® Unternehmensprofil

FOURSTEEL® ist ein portugiesischer Hersteller von Design-Heizkörper mit modernem und minimalistischem Konzept.

Die Investition in Forschung und Entwicklung und insbesondere der Fokus auf die Marktbedürfnisse haben es FOURSTEEL® ermöglicht, in Zusammenarbeit mit Architekten und Designern effiziente Heizlösungen mit raffinierter Ästhetik zu entwickeln, wobei diese Entwicklung das Niveau auf nationaler und internationaler Ebene aufrecht erhält.

© 2016 FOURSTEEL®

[heating products factory]

Book 16 Druckort Aveiro (Portugal). Alle Rechte vorbehalten.

FOURSTEEL® behält sich vor, alle Produkte und die zugehörigen Zeichnungen in diesem Katalog ohne vorherige Ankündigung zu ändern. Alle FOURSTEEL®-Produkte sind in Bezug auf Größe und Füllvolumen anpassbar.

RAUM- UND BADHEIZKÖRPER

MINIMALIST COLLECTION

- 08 Minimal
- 14 Minimal X
- 20 M Tube
- 24 M Tube Square
- 28 M Tube Round
- 30 M Slim
- 34 M Slim Square
- 38 Fourslim by Architects
- 44 Fourslim on/off
- 46 Fourslim Square
- 52 Fourslim Square on/off
- 54 Fourslim Square LED
- 56 Skinny

THE EVOLUTION

- 62 Steel Glam
- 74 Steel Elegance
- 78 Fourfoz
- 84 Steel Wave
- 88 Steel Stone

FIRST COLLECTION

- 94 Steel Classic
- 98 Steel Glamour
- 102 Steel Style

REWIND COLLECTION

- 108 Empress
- 114 Old Beauty
- 120 Remind
- 124 Floor Remind
- 130 Retro special
- 136 Old Grace
- 140 Royalty

NEW COLLECTION

New Slim	146
New Square	150
New Q	154

BASIC LINE

Basic Line	160
------------	-----

DESIGN COLLECTION

Diamond	168
Diamond XS	172
Arena	176
Arena Table	182

ROOM RADIATORS

Curve	186
D Ligne	194
Divine	200
Linear	206
Plano Move	212
Plano Pure	218
Plano Pure on/off	224
Plano +	226
Plano	232

ZUBEHÖR

Domotic Touch	240
Mimoo Switch	244
Elektrische Heizpatronen	246
Heizkörperventile	248
Sonstiges Zubehör	256

WENN SIE NICHT IDENTIFIZIERT DIE POSITION VOM ELEKTRISCHE HEIZPATRONE ,
DER ELEKTRISCHE HEIZPATRONE IST INSTALLIERT IN DIE RECHTS
UNTERSEITE VOM HEIZKÖRPER.

Sonderfarben nach RAL (Bestätigung erforderlich)

Standardfarbe Weiß (RAL 9016)

MINIMALIST COLLECTION

MINIMAL	08
MINIMAL X	14
M TUBE	20
M TUBE SQUARE	24
M TUBE ROUND	28
M SLIM	30
M SLIM SQUARE	34
FOURSLIM BY ARCHITECTS	38
FOURSLIM ON/OFF	44
FOURSLIM SQUARE	46
FOURSLIM SQUARE ON/OFF	52
FOURSLIM SQUARE LED	54
SKINNY	56

MINIMAL

HANDTUCHWÄRMER

ARCHITEKT: MANUEL AIRES MATEUS

Der elektrische Handtuchwärmer MINIMAL, ein minimalistisches Konzept, wurde in Zusammenarbeit mit dem Architekten Manuel Aires Mateus für das Projekt Condomínio Palácio Condes de Murça in Lissabon kreiert und entwickelt.





MINIMAL



DRAUFSICHT

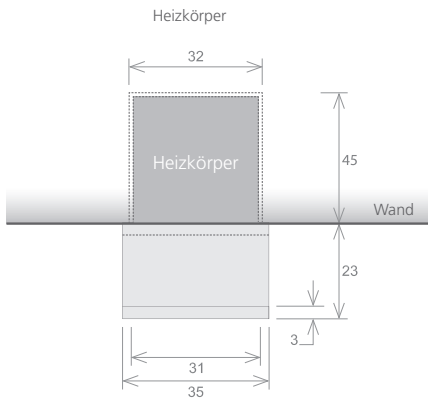

VORDERANSICHT

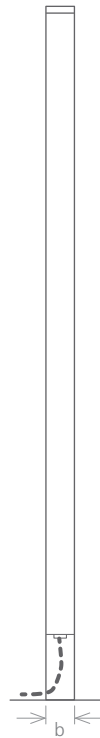

SEITENSICHT





MATERIAL Edelstahl

OBERFLÄCHE



POLIERT



GEBÜRSTET



SCHWARZ



WEISS



RAL FARBEN

TITANBESCHICHTET *



ALTGOLD



GOLD



KUPFER

VORDERANSICHT

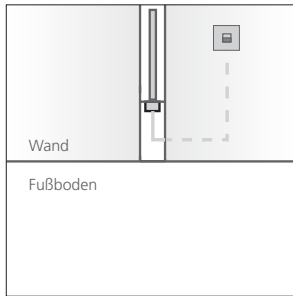

SEITENANSICHT

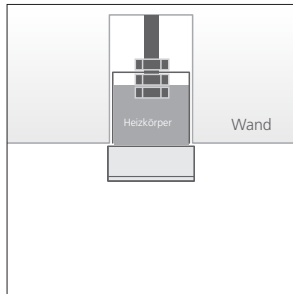
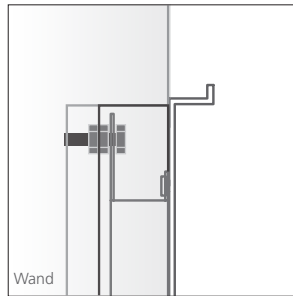

DRAUFSICHT

ZUBEHÖR



MIMOO
SWITCH



DOMOTIC
TOUCH

Modell	M 900	M 1200	M 1400	M 1800
Höhe (mm) a	900	1200	1400	1800
Gesamtbreite (mm) b	35	35	35	35
Tiefe (mm) c	23	23	23	23
Füllvolumen (l)	0,6	0,8	1,0	1,3
El. Leistung (W)	100	150	150	200



MINIMAL X



MINIMAL X

MATERIAL Edelstahl

OBERFLÄCHE



POLIERT



GEBÜRSTET



SCHWARZ



WEISS



RAL FARBEN

TITANBESCHICHTET *



ALTGOLD



GOLD



KUPFER



ZUBEHÖR



MIMOO
SWITCH



DOMOTIC
TOUCH

Modell		MX 900	MX 1200	MX 1400	MX 1800
Höhe (mm)	a	900	1200	1400	1800
Gesamtbreite (mm)	b	50	50	50	50
Tiefe (mm)	c	50	50	50	50
Füllvolumen (l)		0,6	0,8	1,0	1,3
El. Leistung (W)		40	100	150	150

MINIMAL X



DRAUFSICHT

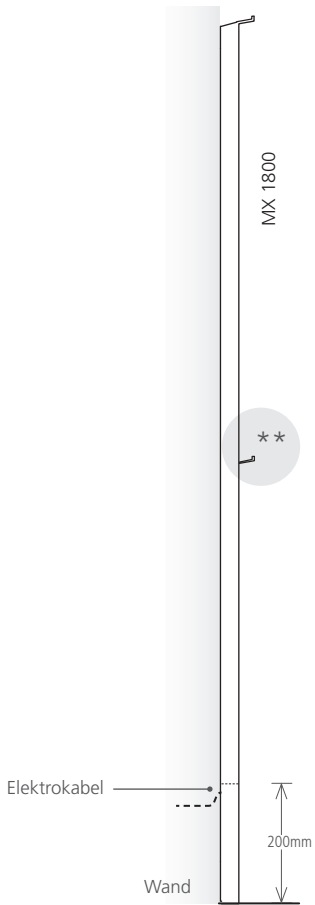

VORDERANSICHT

SEITENSICHT

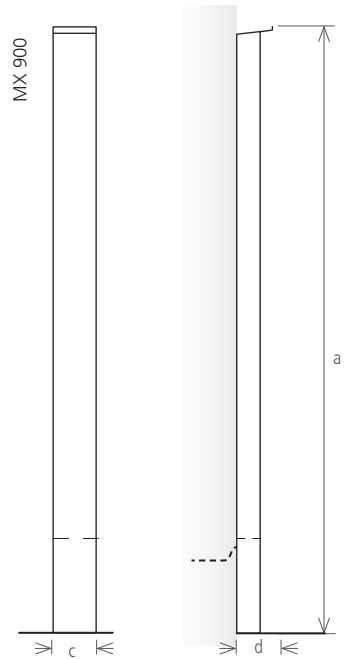

** Nur das Modell MX1800 enthält einen zweiten Handtuchhaken.

M TUBE

HANDTUCHWÄRMER

M Tube wurde als Fortsetzung der minimalistischen Serie von Foursteel® mit dem Ziel kreiert, einen Handtuchwärmer für kleine Räume zu schaffen. Erhältlich aus Edelstahl in den Ausführungen Weiß, Schwarz texturiert, poliert oder gebürstet.





MATERIAL Edelstahl

OBERFLÄCHE



POLIERT



GEBÜRSTET



SCHWARZ
TEXTURIERT



WEISS



RAL FARBEN

TITANBESCHICHTET *



ALTGOLD



GOLD



KUPFER

VORDERANSICHT

SEITENANSICHT

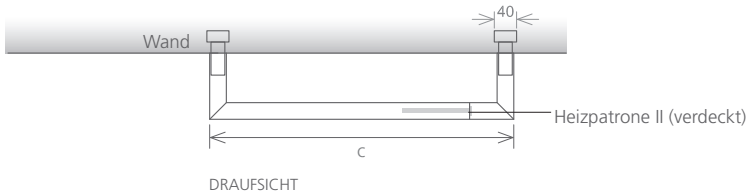
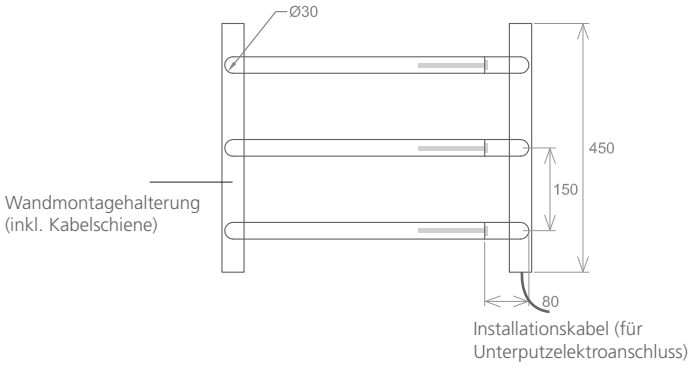

ZUBEHÖR



MIMOO
SWITCH



DOMOTIC
TOUCH

Modell	zus.		zus.	
	MT3 550	Heizelement	MT3 800	Heizelement
Anzahl der Heizelemente	3	1	3	1
Höhe (mm) a	30	30	30	30
Rohrabstand (mm) b	120	-	120	-
Gesamtbreite (mm) c	550	550	800	800
Tiefe (mm) d	120	120	120	120
Füllvolumen (l)	3x0,4	0,4	3x0,6	0,6
El. Leistung (W)	3x40	40	3x40	40

M TUBE SQUARE

HANDTUCHWÄRMER



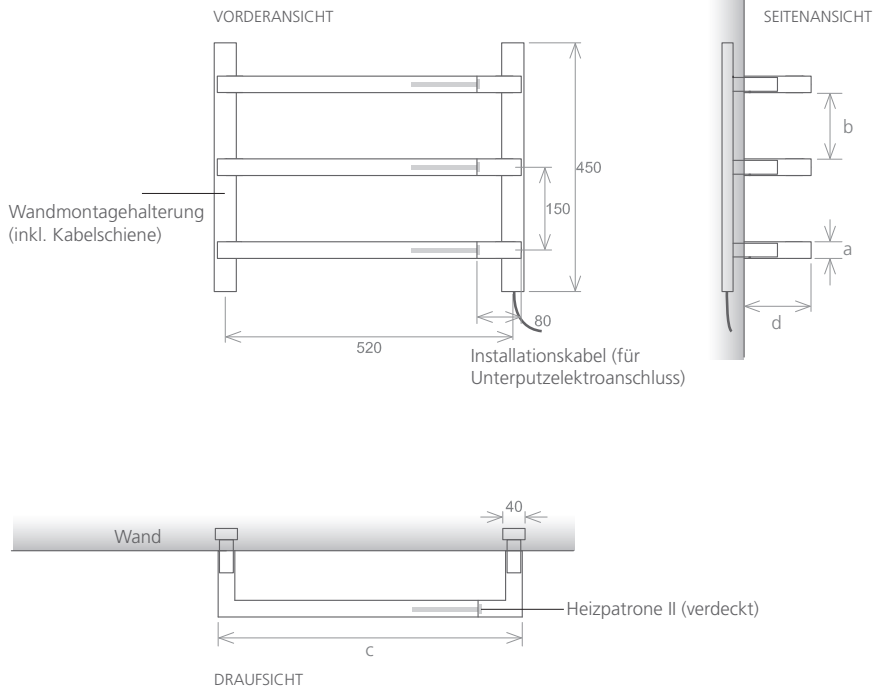



MATERIAL Edelstahl

OBERFLÄCHE



POLIERT



GEBÜRSTET



SCHWARZ
TEXTURIERT



WEISS



RAL FARBEN

TITANBESCHICHTET *



ALTGOLD



GOLD



KUPFER



ZUBEHÖR



MIMOO
SWITCH



DOMOTIC
TOUCH

Modell	MTS3 550	zus. Heizelement	MTS3 800	zus. Heizelement
Anzahl der Heizelemente	3	1	3	1
Höhe des Heizelements (mm) a	30	30	30	30
Rohrabstand (mm) b	120	-	120	-
Gesamtbreite (mm) c	550	550	800	800
Tiefe (mm) d	120	120	120	120
Füllvolumen (l)	3x0,4	0,4	3x0,6	0,6
El. Leistung (W)	3x40	40	3x40	40

M TUBE ROUND

HANDTUCHWÄRMER



MATERIAL Edelstahl

OBERFLÄCHE



POLIERT



GEBÜRSTET



SCHWARZ
TEXTURIERT



WEISS



RAL FARBEN

TITANBESCHICHTET *



ALTGOLD



GOLD



KUPFER

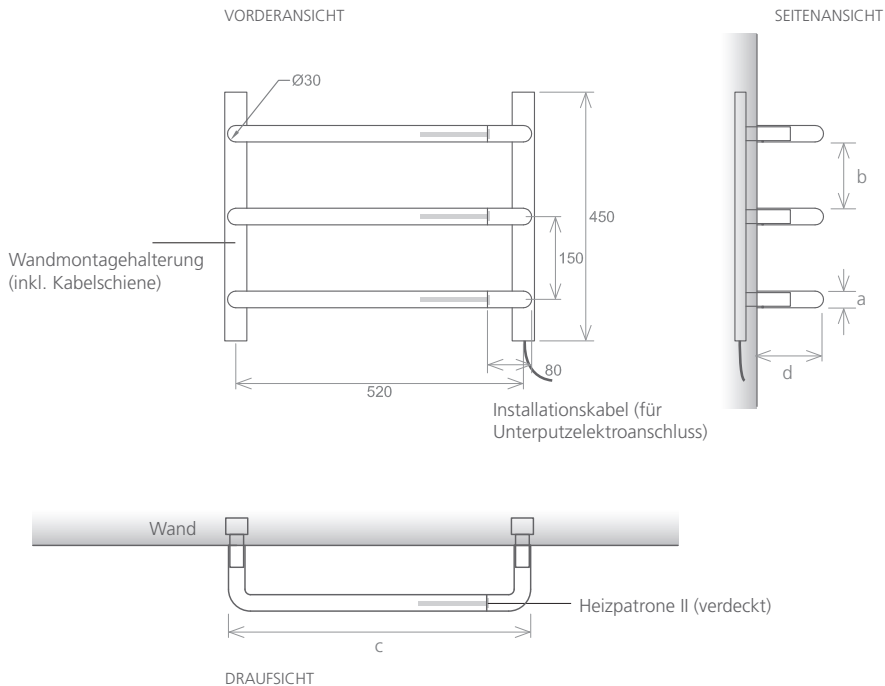

ZUBEHÖR



MIMOO
SWITCH



DOMOTIC
TOUCH

Modell	MTR3 550		zus. Heizelement		MTR3 800		zus. Heizelement	
	Anzahl der Heizelemente		3	1	3	1		
Höhe (mm)	a	30	30	30	30	30	30	
Rohrabstand (mm)	b	120	-	120	-	120	-	
Gesamtbreite (mm)	c	550	550	800	800	800	800	
Tiefe (mm)	d	120	120	120	120	120	120	
Füllvolumen (l)		3x0,4	0,4	3x0,6	0,6	3x0,6	0,6	
El. Leistung (W)		3x40	40	3x40	40	3x40	40	

M SLIM

HANDTUCHWÄRMER

M Slim wurde als fortsetzung der minimalistischen serie von Foursteel®.
Erhältlich aus edelstahl poliert oder gebürstet, in den ausführungen Ral
farben und titanbeschichtet (gold und kupfer).



M SLIM

HANDTUCHWÄRMER

Vorderansicht

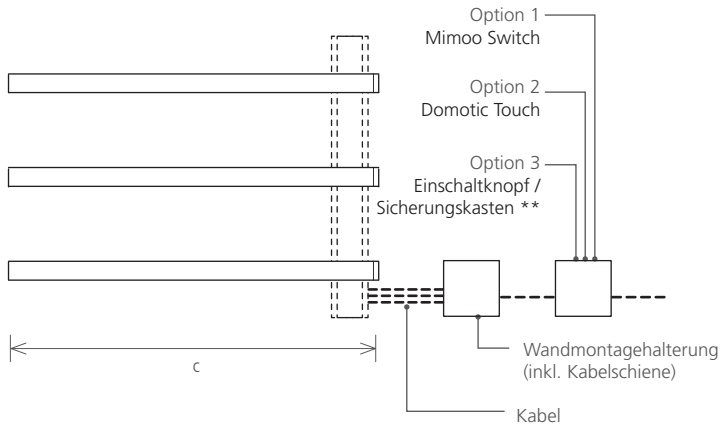

** Nicht bei Foursteel erhältlich.

MATERIAL Edelstahl

OBERFLÄCHE



POLIERT



GEBÜRSTET



SCHWARZ
TEXTURIERT



WEISS



RAL FARBEN

TITANBESCHICHTET *



ALTGOLD



GOLD



KUPFER

Seitenansicht

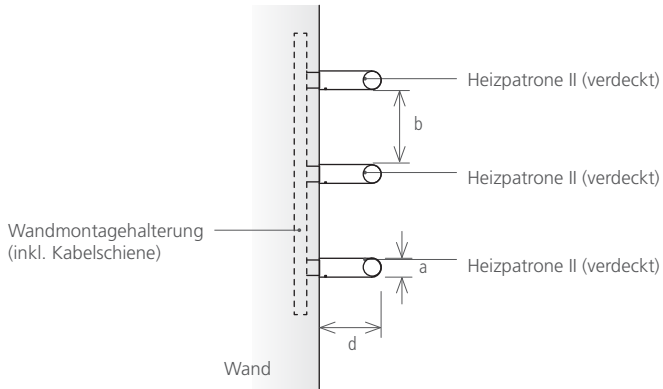

ZUBEHÖR



MIMOO
SWITCH



DOMOTIC
TOUCH

Modell	MS3 600	zus. Heizelement
Anzahl der Heizelemente	3	1
Höhe (mm) a	30	30
Rohrabstand (mm) b	120	-
Gesamtbreite (mm) c	600	600
Tiefe (mm) d	80	90
Füllvolumen (l)	3x0,6	0,6
El. Leistung (W)	3x40	40

M SLIM SQUARE

HANDTUCHWÄRMER

M Slim Square wurde als fortsetzung der minimalistischen serie von Foursteel®. Erhältlich aus edelstahl poliert oder gebürstet, in den ausführungen Ral farben und titanbeschichtet (gold und kupfer).



M SLIM SQUARE

HANDTUCHWÄRMER

Vorderansicht

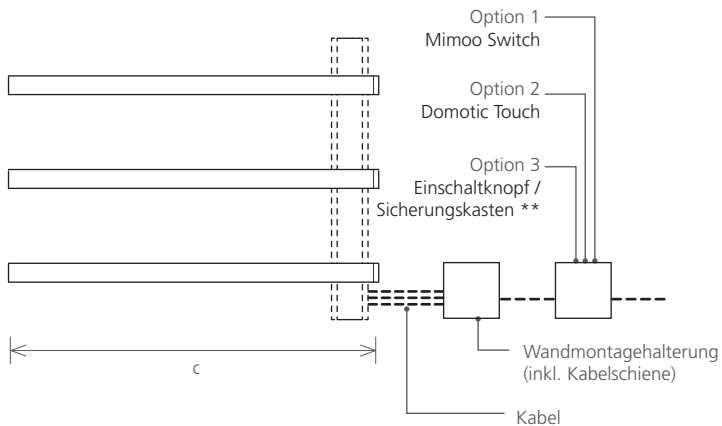

** Nicht bei Foursteel erhältlich.

MATERIAL Edelstahl

OBERFLÄCHE



POLIERT



GEBÜRSTET



SCHWARZ
TEXTURIERT



WEISS



RAL FARBEN

TITANBESCHICHTET *



ALTGOLD



GOLD



KUPFER

Seitenansicht

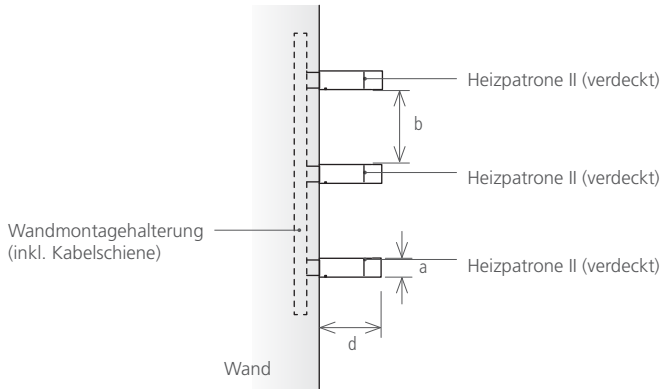

ZUBEHÖR



MIMOO
SWITCH



DOMOTIC
TOUCH

Modell	MSS3 600	zus. Heizelement
Anzahl der Heizelemente	3	1
Höhe (mm) a	30	30
Rohrabstand (mm) b	120	-
Gesamtbreite (mm) c	600	600
Tiefe (mm) d	80	80
Füllvolumen (l)	3x0,6	0,6
El. Leistung (W)	3x40	40

FOURSLIM BY ARCHITECTS

HANDTUCHWÄRMER

Unter dem Motto "weniger ist mehr" wurde der Handtuchheizkörper Fourslim by Architects in Zusammenarbeit mit dem Atelier Manuel Aires Mateus entwickelt. Fourslim ist ein Handtuchrockner, der mit zwei, drei oder mehr Heizelementen in demselben Raum genutzt werden kann. Als Warmwasser-, Elektro- oder Mischbetrieb schafft dieser Handtuchheizkörper eine einzigartige Atmosphäre.



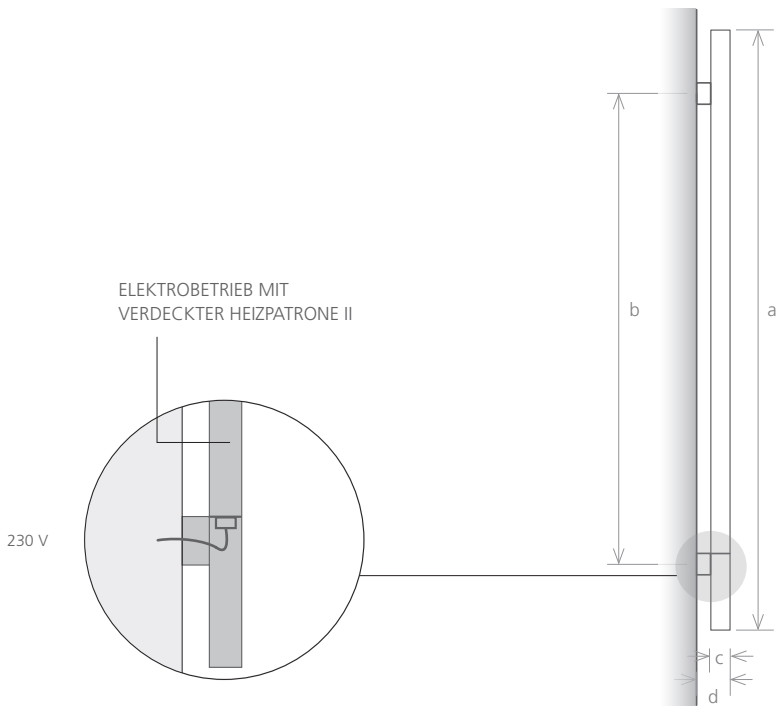

Elektrobetrieb: In der horizontalen Position beträgt die Tiefe 75 mm.

Modell	Heizpatrone II (verdeckt)			Mischbetrieb		
	FS 800	FS 1200	FS 1400	FSM 800	FSM 1200	FSM 1400
Höhe (mm) a	800	1200	1400	880	1280	1480
Achsabstand (mm) b	645	945	1145	620	1020	1220
Gesamtbreite (mm) c	35	35	35	42	42	42
Tiefe (mm) d	65	65	65	100	100	100
Füllvolumen (l)	0,6	0,8	1,0	0,7	0,9	1,2
Zentralzlg.betr. (W)	-	-	-	63	97	124
El. Leistung (W)	40	100	150	40	100	150



MATERIAL Edelstahl

OBERFLÄCHE



POLIERT



GEBÜRSTET



SCHWARZ
TEXTURIERT



WEISS



RAL FARBEN

TITANBESCHICHTET *



ALTGOLD



GOLD



KUPFER



Elektrobetrieb II (verdeckt)



Domotic Touch (optional)

ZUBEHÖR



ANSCHLUSS-
ARMATUR-SET



MIMOO
SWITCH



DOMOTIC
TOUCH

ZENTRALHZG.BETR.

lösung 1

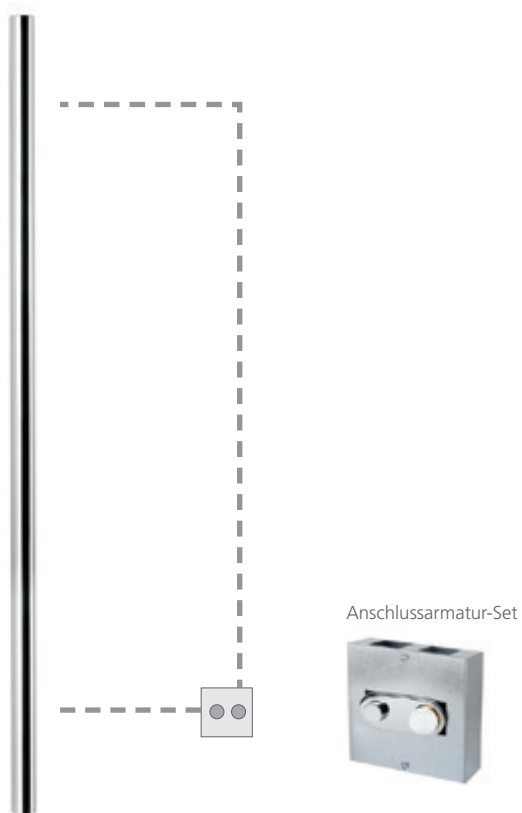

ZENTRALHZG.BETR.
lösung 2

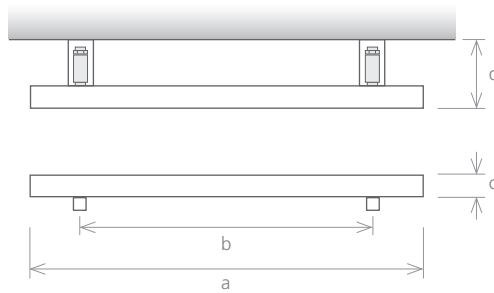

Modell	LÖSUNG 1			LÖSUNG 2		
	FSA 800	FSA 1200	FSA 1400	FSA 800	FSA 1200	FSA 1400
Höhe (mm) a	800	1200	1400	800	1200	1400
Nabenabstand (mm) b	620	1020	1220	620	1020	1220
Gesamtbreite (mm) c	42	42	42	42	42	42
Tiefe (mm) d	100	100	100	130	130	130
Füllvolumen (l)	0,7	0,9	1,2	0,7	0,9	1,2
Zentralhzbetr. (W)	63	97	124	63	97	124

FOURSLIM ON/OFF

HANDTUCHWÄRMER



Um für einen höheren Bedienungskomfort zu sorgen, wurde in diesem Handtuchwärmer ein Einschaltknopf integriert.

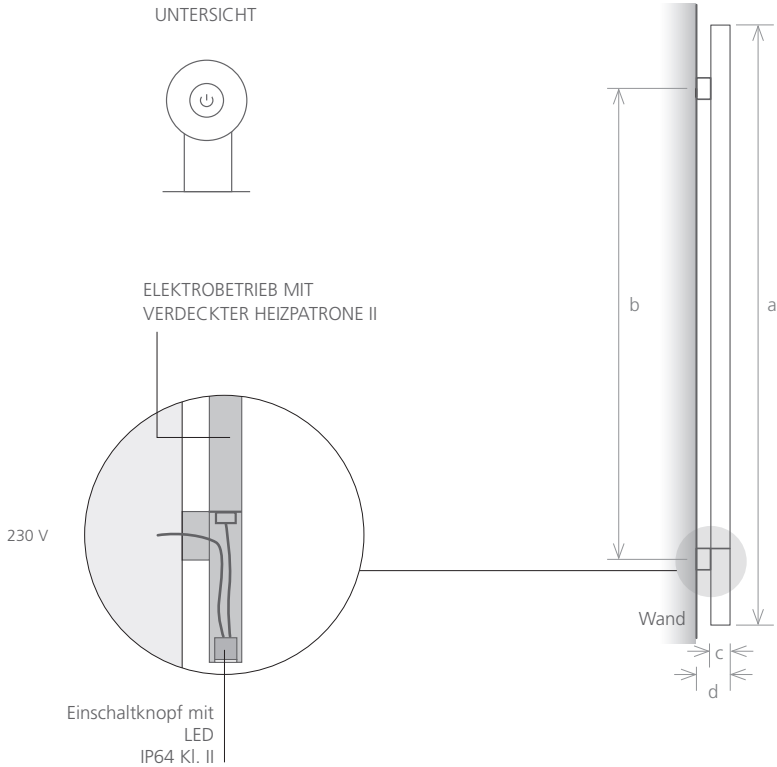

Elektrobetrieb: In der horizontalen Position beträgt die Tiefe 82 mm.

Modell	Elektrobetrieb II			Mischbetrieb		
	FSO 800	FSO 1200	FSO 1400	FSOM 800	FSOM 1200	FSOM 1400
Höhe (mm) a	800	1200	1400	880	1280	1480
Achsabstand (mm) b	645	945	1145	620	1020	1220
Gesamtbreite (mm) c	42	42	42	42	42	42
Tiefe (mm) d	72	72	72	100	100	100
Füllvolumen (l)	0,6	0,8	1,0	0,7	0,9	1,2
Zentralhgz.betr. (W)	-	-	-	63	97	124
El. Leistung (W)	40	100	150	40	100	150

FOURSLIM SQUARE

HANDTUCHWÄRMER

Aus der Fourslim-Serie entstand der Handtuchwärmer Fourslim Square im Vierkantrohrprofil. Diese vielseitige Kollektion verfügt über eine horizontale sowie eine vertikale Ausführung.



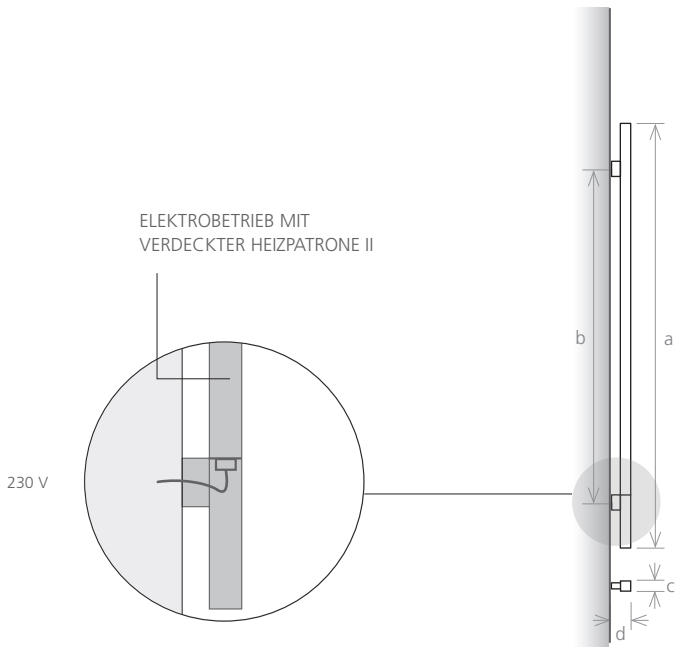

Elektrobetrieb: In der horizontalen Position beträgt die Tiefe 80 mm.

Modell	Heizpatrone II (verdeckt)			Mischbetrieb		
	FSQ 800	FSQ 1200	FSQ 1400	FSQM 800	FSQM 1200	FSQM 1400
Höhe (mm) a	800	1200	1400	880	1280	1480
Achsabstand (mm) b	645	945	1145	620	1020	1220
Gesamtbreite (mm) c	40	40	40	40	40	40
Tiefe (mm) d	70	70	70	98	98	98
Füllvolumen (l)	0,6	0,8	1,0	0,7	0,9	1,2
Zentralhgz.betr. (W)	-	-	-	63	97	124
El. Leistung (W)	40	100	150	40	100	150



MATERIAL Edelstahl

OBERFLÄCHE



POLIERT



GEBÜRSTET



SCHWARZ
TEXTURIERT



WEISS



RAL FARBEN

TITANBESCHICHTET *



ALTGOLD



GOLD



KUPFER



Elektrobetrieb II (verdeckt)



Domotic Touch (optional)

ZUBEHÖR



ANSCHLUSS-
ARMATUR-SET



MIMOO
SWITCH



DOMOTIC
TOUCH

ZENTRALHZG.BETR.
lösung 1



Anschlussarmatur-Set



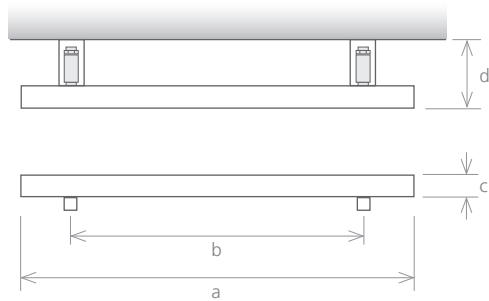

Modell	LÖSUNG 1			LÖSUNG 2		
	FSQA 800	FSQA 1200	FSQA 1400	FSQA 800	FSQA 1200	FSQA 1400
Höhe (mm) a	800	1200	1400	800	1200	1400
Nabenabstand (mm) b	620	1020	1220	620	1020	1220
Gesamtbreite (mm) c	40	40	40	40	40	40
Tiefe (mm) d	98	98	98	128	128	128
Füllvolumen (l)	0,7	0,9	1,2	0,7	0,9	1,2
Zentralhzg.betr. (W)	63	97	124	63	97	124

FOURSLIM SQUARE ON/OFF

HANDTUCHWÄRMER



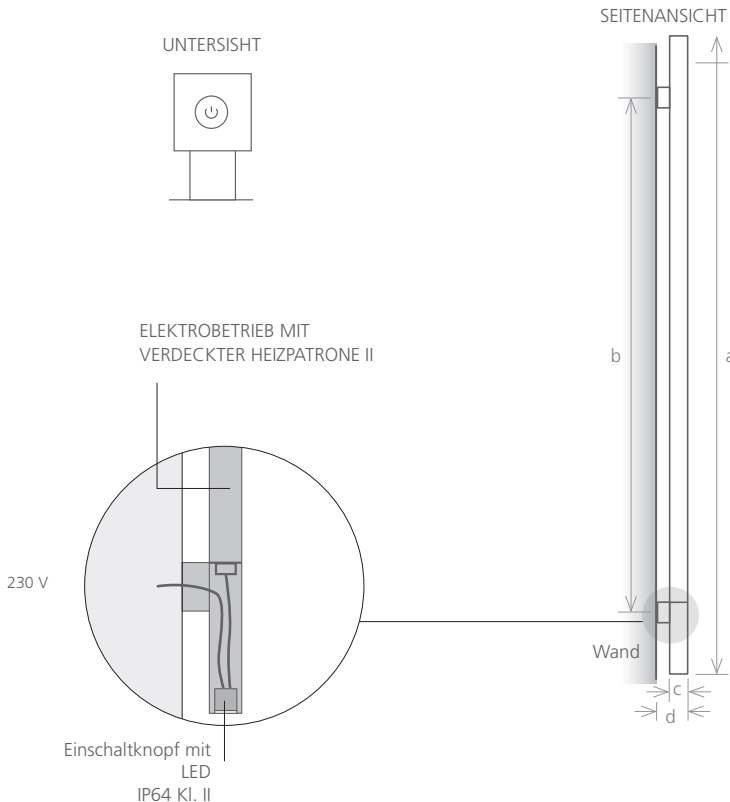

Elektrobetrieb: In der horizontalen Position beträgt die Tiefe 80 mm.

Modell	Heizpatrone II (verdeckt)			Mischbetrieb		
	FSQO 800	FSQO 1200	FSQO 1400	FSQOM 800	FSQOM 1200	FSQOM 1400
Höhe (mm) a	800	1200	1400	880	1280	1480
Achsabstand (mm) b	645	945	1145	620	1020	1220
Gesamtbreite (mm) c	40	40	40	40	40	40
Tiefe (mm) d	70	70	70	98	98	98
Füllvolumen (l)	0,6	0,8	1,0	0,7	0,9	1,2
Zentralhgz.betr. (W)	-	-	-	63	97	124
El. Leistung (W)	40	100	150	40	100	150



FOURSLIM SQUARE LED

HANDTUCHWÄRMER

Der elektrische Handtuchwärmer Fourslim Square Led liefert nicht nur Wärme, er spendet auch ein subtiles Umgebungslicht mit niedrigem Energieverbrauch.

Diese beiden Funktionen können nacheinander oder gleichzeitig benutzt werden.



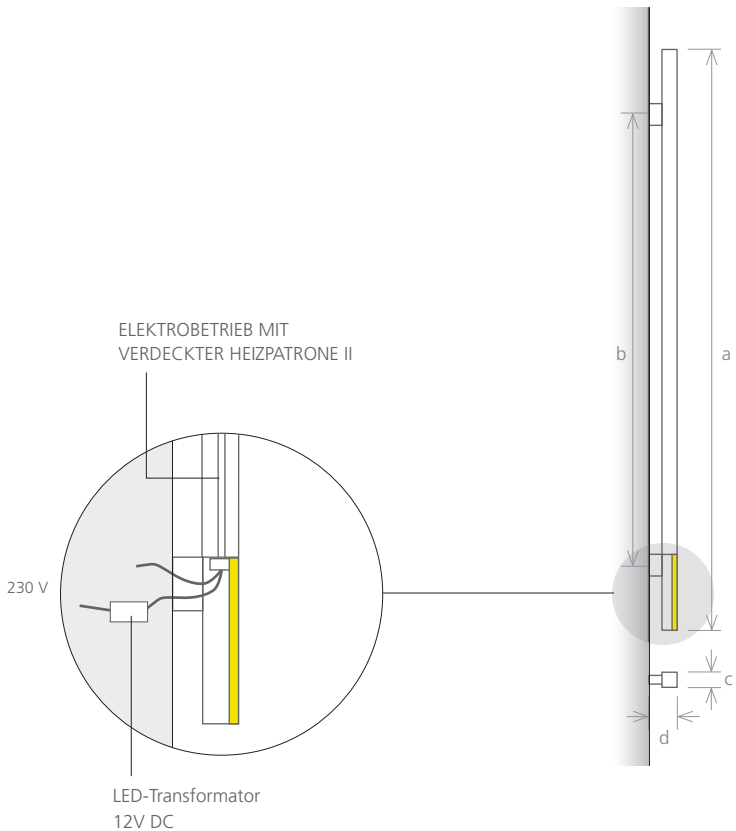

Modell	FSQL 800	FSQL 1200	FSQL 1400
Höhe (mm) a	800	1200	1400
Achsabstand (mm) b	645	945	1145
Gesamtbreite (mm) c	40	40	40
Tiefe (mm) d	70	70	70
Füllvolumen (l)	0,6	0,8	1,0
El. Leistung (W)	40	100	150

SKINNY

HANDTUCHWÄRMER

Der elektrische Handtuchrockner SKINNY zeichnet sich durch seine minimalistische Essenz aus. Durch die Kombination mehrerer Elemente kann eine individuelle Zusammenstellung geschaffen werden, die überall angebracht werden kann, sei es als Bodenmontage oder mobil mit Standfuß.



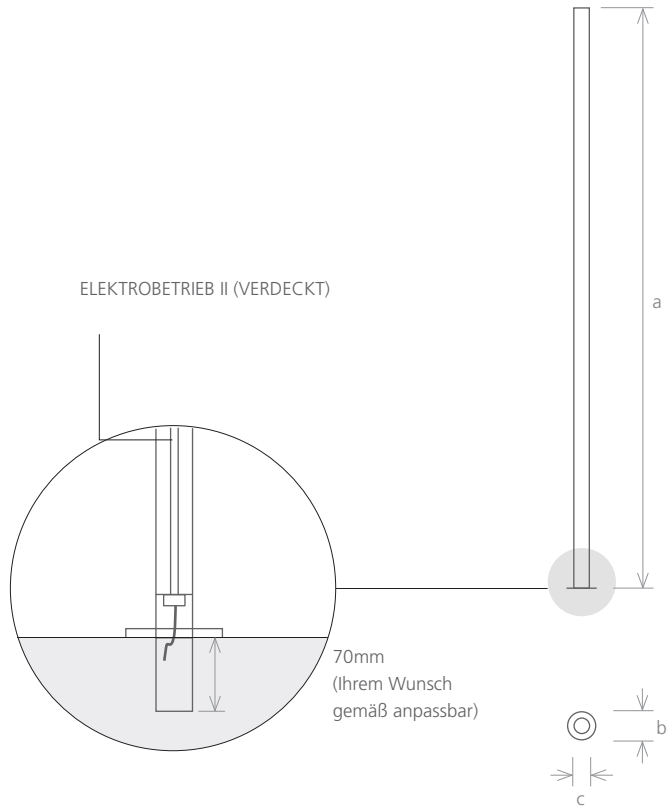

		feststehend			beweglich		
Modell		SK 900	SK 1200	SK 1400	SKM 900	SKM 1200	SKM 1400
Höhe (mm)	a	900	1200	1400	900	1200	1400
Gesamtbreite (mm)	b	90	90	90	280	280	280
Rohrdurchmesser (mm)	c	42	42	42	42	42	42
Füllvolumen (l)		0,6	0,8	1,0	0,6	0,8	1,0
El. Leistung (W)		40	100	150	40	100	150

VERSION: BEWEGLICH



MATERIAL Edelstahl

OBERFLÄCHE



POLIERT



GEBÜRSTET



SCHWARZ
TEXTURIERT



WEISS



RAL FARBEN

TITANBESCHICHTET *



ALTGOLD



GOLD



KUPFER

VALDERANSICHT

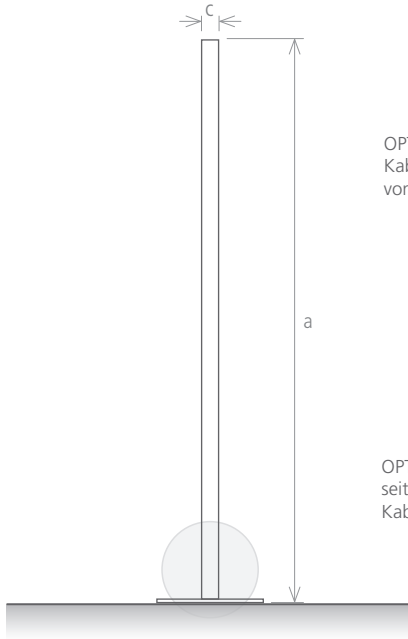

OPTION A
Kabelausgang
von unten

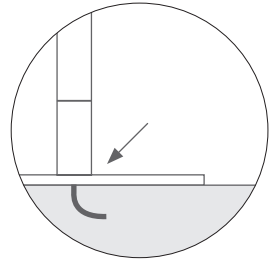

OPTION B
seitlicher
Kabelausgang

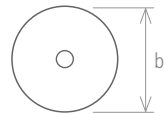
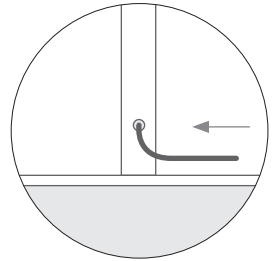

DRAUFSICHT

ANMERKUNG: Auch erhältlich in der Ausführung "Square".

ZUBEHÖR



MIMOO
SWITCH



DOMOTIC
TOUCH

WENN SIE NICHT IDENTIFIZIERT DIE POSITION VOM ELEKTRISCHE HEIZPATRONE ,
DER ELEKTRISCHE HEIZPATRONE IST INSTALLIERT IN DIE RECHTS
UNTERSEITE VOM HEIZKÖRPER.

Sonderfarben nach RAL (Bestätigung erforderlich)

Standardfarbe Weiß (RAL 9016)

THE EVOLUTION

design collection by architects

STEEL GLAM	62
STEEL ELEGANCE	74
FOURFOZ	78
STEEL WAVE	84
STEEL STONE	88

STEEL GLAM

BADHEIZKÖRPER

ARCHITEKT: GONÇALO BYRNE

Unter Berücksichtigung ästhetischer Aspekte entstand der Steel Glam geradlinig und im Vierkantprofil als Heizlösung für den Wärmebedarf des prachtvollen Gebäudes Estoril Sol Residence in Lissabon.

Durch die Kontinuität der Serie trifft Foursteel® mit dem Steel Glameine sichere Wahl bei der Entwicklung zeitgemäßer Design-Heizkörper.





MATERIAL Edelstahl

OBERFLÄCHE



POLIERT



GEBÜRSTET



SCHWARZ
TEXTURIERT



WEISS



RAL FARBEN

TITANBESCHICHTET *



ALTGOLD



GOLD



KUPFER



ZUBEHÖR



MIMOO
SWITCH



DOMOTIC
TOUCH

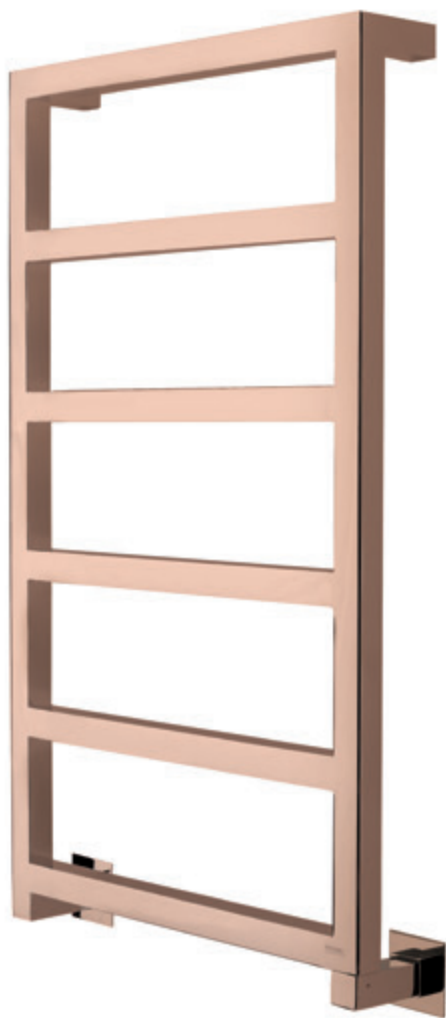



ZENTRALHEIZUNGSBETRIEB

VORDERANSICHT

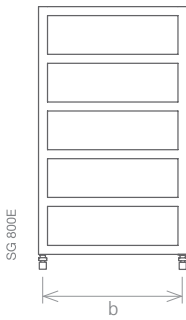

SEITENANSICHT

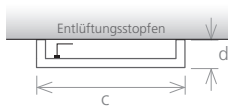

DRAUFSICHT

ELEKTROBETRIEB MIT VERDECKTER HEIZPATRONE II

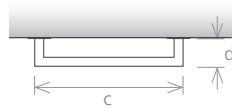
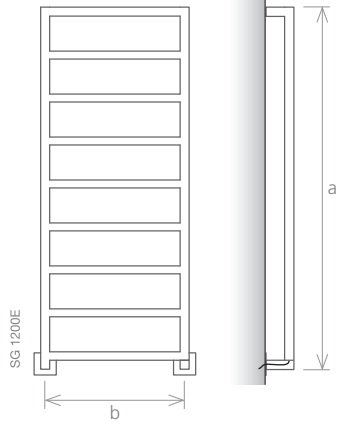



ELEKTROBETRIEB IV

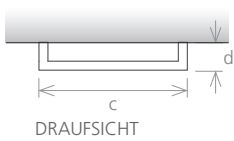
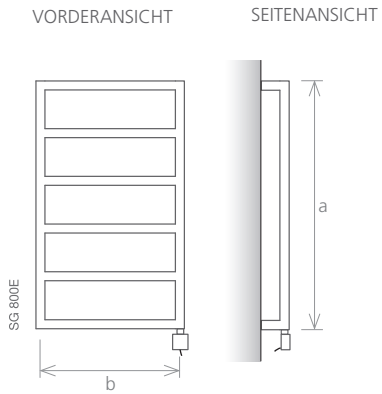

MISCHBETRIEB MIT HEIZPATRONE IV

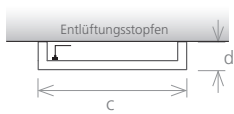
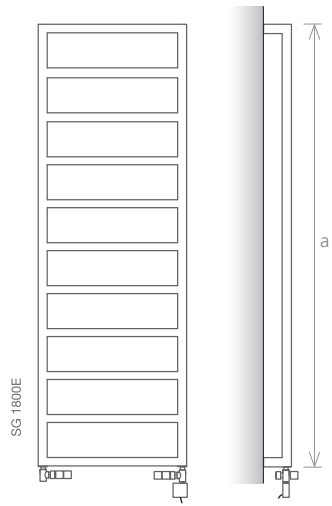





Domotic Touch (optional)



Elektrobetrieb mit verdeckter Heizpatrone II



STEEL GLAM normal
(SG)



STEEL GLAM scharfe Kanten
(SGS)

Modell		SG 800E	SG 800L	SG 1200E	SG 1200L	SG 1800E	SG 1800L
Höhe (mm)	a	800	800	1200	1200	1800	1800
Nabenabstand (mm)	b	450	500	450	500	450	500
Gesamtbreite (mm)	c	480	530	480	530	480	530
Tiefe (mm)	d	90	90	90	90	90	90
Füllvolumen (l)		2,8	3,1	4,0	4,6	6,6	7,1
Zentralhzg.betr. (W)		250	296	360	438	613	657
El. Leistung (W)		300	300	600	600	1000	1000

STEEL ELEGANCE

BADHEIZKÖRPER

Der Steel Elegance ist eine Umgestaltung des Modells Steel Classic (aus der First Collection) und wurde für das Umbauprojekt des Hotels Savoy Madeira entwickelt.

Die Konstruktion wurde durch die Reduzierung der Rohre in den einzelnen Sektionen sowie Änderung des Befestigungssystems in diesem Handtuchwärmer optimiert.

Das sichtbare Ergebnis ist ein Edelstahl-Handtuchheizkörper von schlichter Eleganz und Güte des klassischen Modells im Einklang mit dem Komfort und der Leichtigkeit der Gegenwart.





MATERIAL Edelstahl

OBERFLÄCHE



POLIERT



GEBÜRSTET

ZUBEHÖR



MIMOO
SWITCH



DOMOTIC
TOUCH

ZENTRALHEIZUNGSBETRIEB

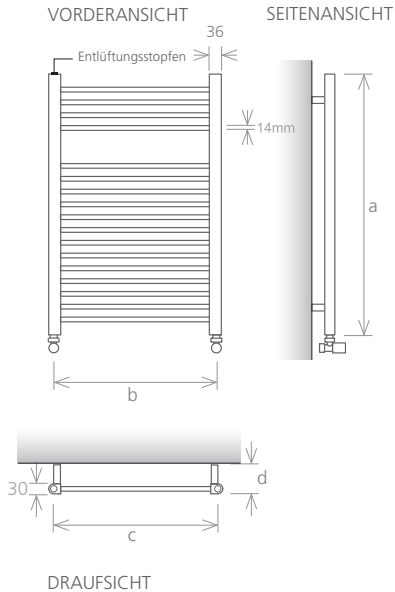

ELEKTROBETRIEB V

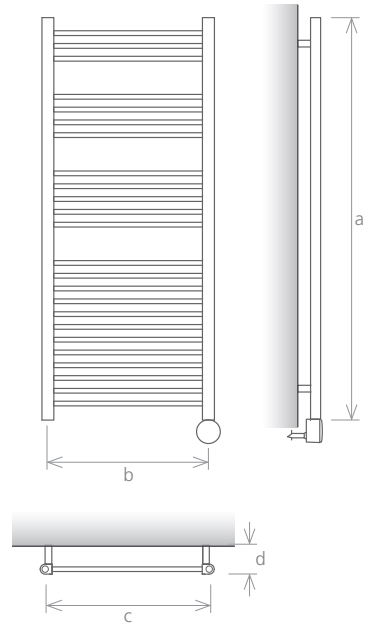

Modell		ELG 800E	ELG 800L	ELG 1200E	ELG 1200L	ELG 1800E	ELG 1800L
Höhe (mm)	a	800	800	1200	1200	1800	1800
Nabenabstand (mm)	b	450	500	450	500	450	500
Gesamtbreite (mm)	c	480	530	480	530	480	530
Tiefe (mm)	d	87	87	87	87	87	87
Füllvolumen (l)		1,6	1,8	2,4	2,7	3,3	3,7
Zentralhgz.betr. (W)		144	160	216	240	377	419
El. Leistung (W)		200	200	300	300	600	600

FOURFOZ

BADHEIZKÖRPER

ARCHITEKT: EDUARDO SOUTO DE MOURA

Der Badheizkörper Fourfoz zeichnet sich im Design durch einen Hauch von Kühnheit bei der Formgebung aus und entstand unter der Leitung des Architekten Eduardo Souto Moura, der seine gestalterische Freiheit mit den funktionalen Anforderungen an einen Handtuchrockner meisterlich zu vereinen wusste.





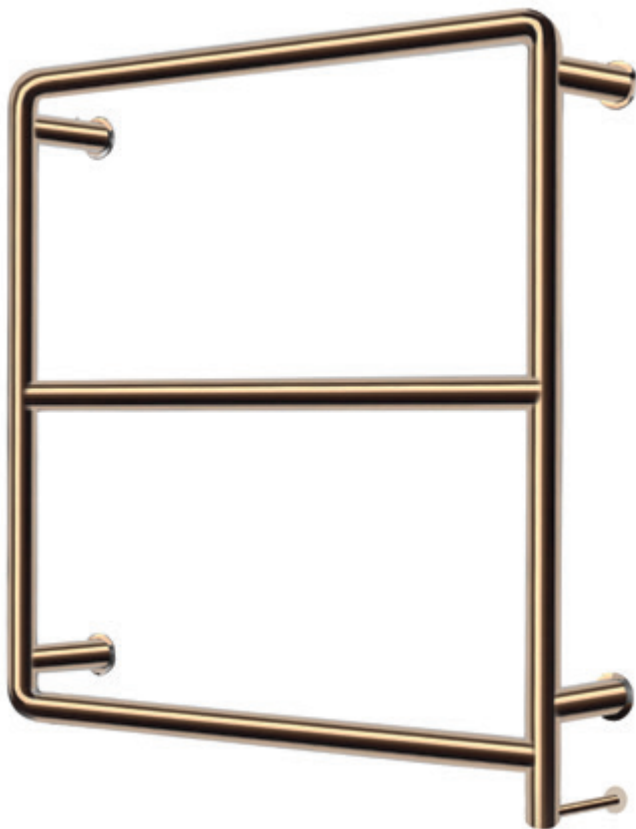

ZENTRALHEIZUNGSBETRIEB

ELEKTROBETRIEB MIT VERDECKTER
HEIZPATRONE II

VORDERANSICHT

SEITENANSICHT

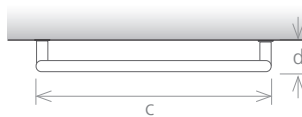
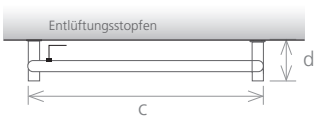
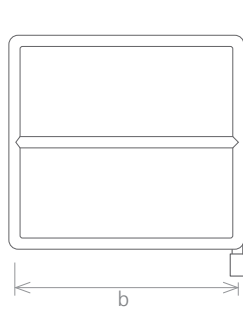
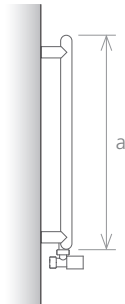
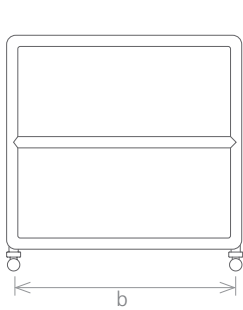

DRAUFSICHT

MATERIAL Edelstahl

OBERFLÄCHE

TITANBESCHICHTET *

ZUBEHÖR



POLIERT



GEBÜRSTET



ALTGOLD



GOLD



KUPFER



MIMO
SWITCH



DOMOTIC
TOUCH

MISCHBETRIEB MIT HEIZPATRONE II

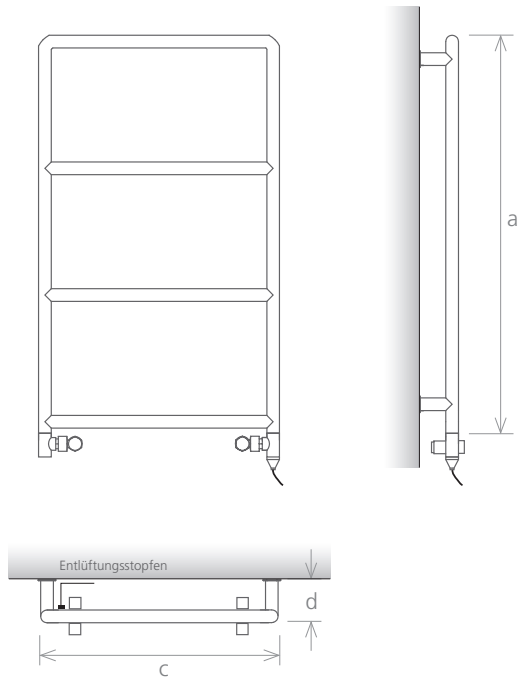

Modell		FF 525E	FF 525L	FF 800E	FF 800L
Höhe (mm)	a	525	525	800	800
Achsabstand (mm)	b	450	500	450	500
Gesamtbreite (mm)	c	475	525	475	525
Tiefe (mm)	d	100	100	100	100
Füllvolumen (l)		0,8	0,8	1,0	1,2
Zentralhgz.betr. (W)		89	98	126	139
El. Leistung (W)		100	100	150	150

STEEL WAVE

BADHEIZKÖRPER

In Anlehnung an die Architektur des Martinhal Beach Resort & Hotel in Sagres wurde der Badheizkörper Steel Wave in Zusammenarbeit mit dem britischen Architektur- und Designbüro Conran & Partners als zeitgemäße und schlichte Lösung konzipiert.

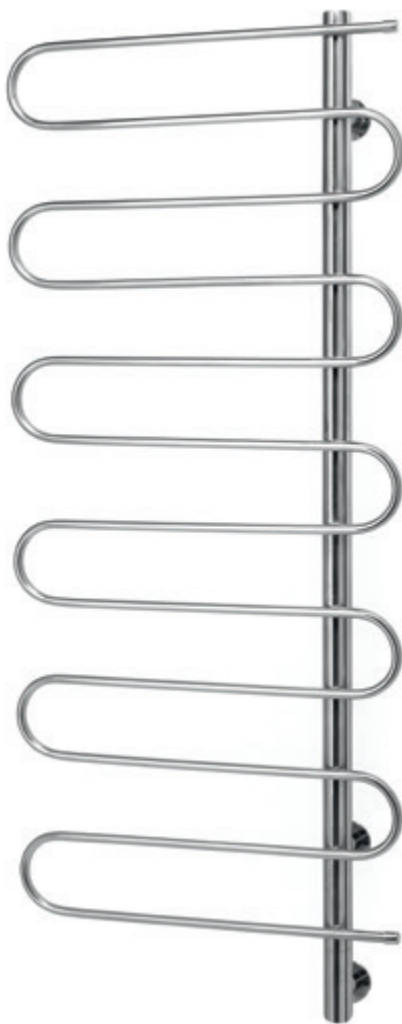



Elektrobetrieb V

MATERIAL Edelstahl

OBERFLÄCHE



POLIERT



GEBÜRSTET

ZUBEHÖR



MIMOO
SWITCH



DOMOTIC
TOUCH

ZENTRALHEIZUNGSBETRIEB

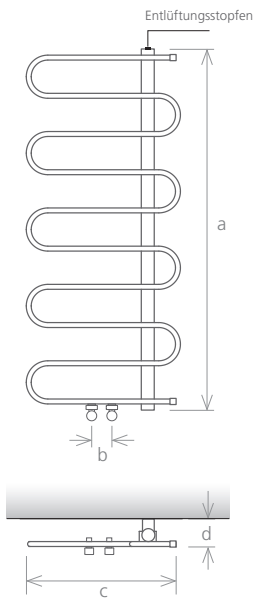

ELEKTROBETRIEB V

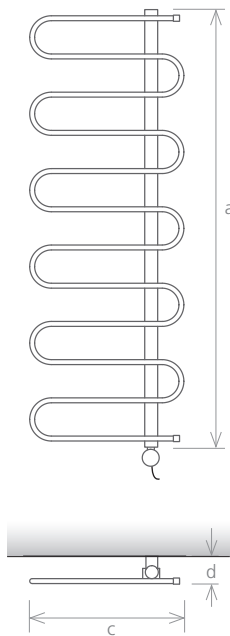

MISCHBETRIEB MIT HEIZPATRONE V

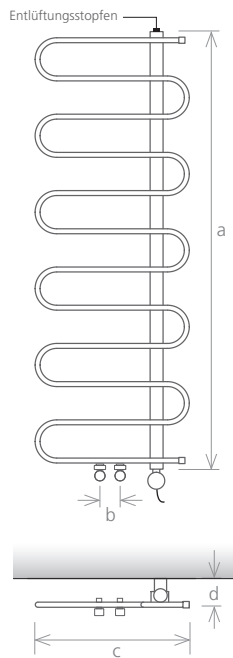

Modell		SW 800L	SW 800XL	SW 1200L	SW 1200XL	SW 1400L	SW 1400XL
Höhe (mm)	a	868	868	1100	1100	1332	1332
Nabenabstand (mm)	b	50	50	50	50	50	50
Gesamtbreite (mm)	c	500	600	500	600	500	600
Tiefe (mm)	d	90	90	90	90	90	90
Füllvolumen (l)		3,1	3,5	4,0	4,6	6,1	6,9
Zentralhgz.betr. (W)		279	317	360	438	545	616
El. Leistung (W)		200	200	300	300	600	600

STEEL STONE

BADHEIZKÖRPER

Dieser Heizkörper wurde in Zusammenarbeit mit dem Architekturbüro José Carlos Cruz entwickelt und sorgt für ein behagliches homogenes Raumklima.

Verwendet man für die Heizkörperverkleidung das gleiche Material wie für die Wandbeschichtung*, kann der Steel Stone an eine Wand befestigt oder in eine Wandnische eingelassen werden, wobei er dann an der Zimmerwand bündig abschließt.

* Das verwendete Beschichtungsmaterial muss eine Hitzebeständigkeit von mindestens 120° C aufweisen.



Elektrobetrieb mit verdeckter Heizpatrone II



Steinplatte (nicht im Lieferumfang
enthalten und bei uns nicht erhältlich)

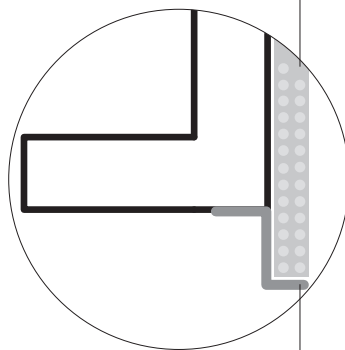

Halterung für die Steinplatte

MATERIAL Edelstahl

OBERFLÄCHE



POLIERT



GEBÜRSTET

ZUBEHÖR



MIMOO
SWITCH



DOMOTIC
TOUCH

ZENTRALHEIZUNGSBETRIEB

VORDERANSICHT

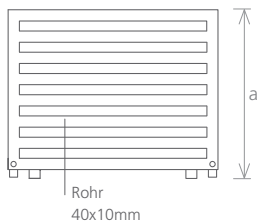

SEITENANSICHT

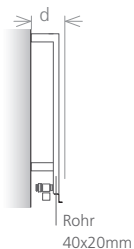

ELEKTROBETRIEB MIT VERDECKTER HEIZPATRONE II

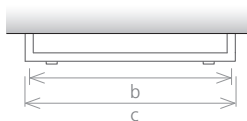
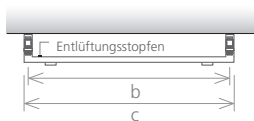
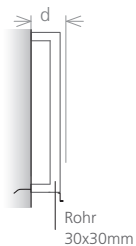
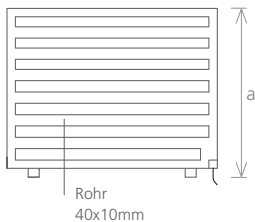

DRAUFSICHT

Modell	SS 600 600	SS 400 900	SS 600 900	SS 400 1200	SS 600 1200	SS 800 1200
Höhe (mm) a	600	400	600	400	600	800
Nabenabstand (mm) b	560	860	860	1160	1160	1160
Gesamtbreite (mm) c	600	900	900	1200	1200	1200
Tiefe (mm) d	110	110	110	110	110	110
Füllvolumen (l)	3,6	4,2	4,7	5,6	5,8	7,2
Zentralhgz.betr. (W)	322	379	419	500	524	647
El. Leistung (W)	300	300	600	600	600	1000

WENN SIE NICHT IDENTIFIZIERT DIE POSITION VOM ELEKTRISCHE HEIZPATRONE ,
DER ELEKTRISCHE HEIZPATRONE IST INSTALLIERT IN DIE RECHTS
UNTERSEITE VOM HEIZKÖRPER.

Sonderfarben nach RAL (Bestätigung erforderlich)

Standardfarbe Weiß (RAL 9016)

FIRST COLLECTION

everyone is unique, every space in your home
must be you, must be unique

STEEL CLASSIC	94
STEEL GLAMOUR	98
STEEL STYLE	102

STEEL CLASSIC

BADHEIZKÖRPER

Die herausragende Qualität dieses Badheizkörpers wird durch das Fehlen von sichtbaren Schweißnähten, guter Wärmeleitfähigkeit und Haltbarkeit gewährleistet. Der Steel Classic bietet durch seine exzellente Ausstattung eine besondere Gelegenheit zur Aufwertung des Badambientes.





MATERIAL Edelstahl

OBERFLÄCHE



POLIERT



GEBÜRSTET

ZUBEHÖR



MIMOO
SWITCH



DOMOTIC
TOUCH

ZENTRALHEIZUNGSBETRIEB

ELEKTROBETRIEB V

MISCHBETRIEB MIT HEIZPATRONE II

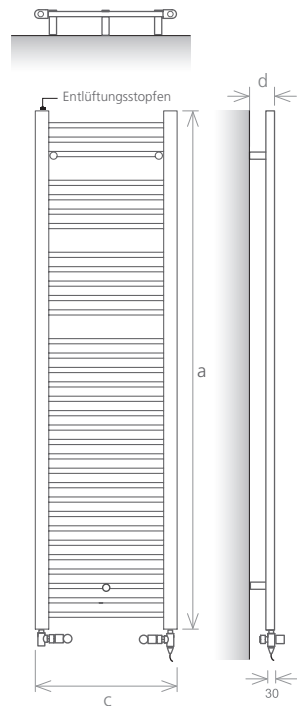
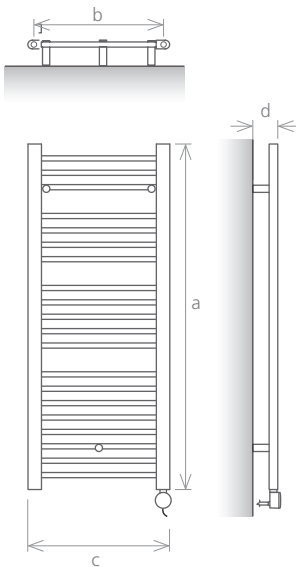
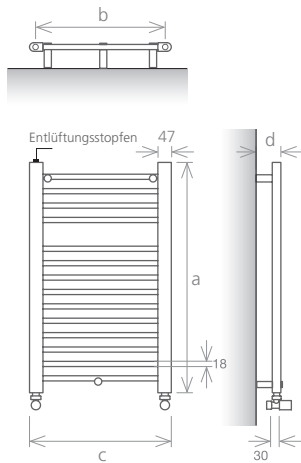

Modell		T 800E	T 800L	T 1200E	T 1200L	T 1800E	T 1800L
Höhe (mm)	a	800	800	1200	1200	1800	1800
Nabenabstand (mm)	b	450	500	450	500	450	500
Gesamtbreite (mm)	c	492	542	492	542	492	542
Tiefe (mm)	d	87	87	87	87	87	87
Füllvolumen (l)		2,5	2,6	3,6	3,7	5,6	5,9
Zentralhgz.betr. (W)		221	234	323	353	497	547
El. Leistung (W)		300	300	600	600	1000	1000

STEEL GLAMOUR

BADHEIZKÖRPER

Steel Glamour spiegelt die neuen Design-Trends wider: Geradlinige Einfachheit mit Modernität und ungeschmückter Eleganz zu kombinieren, um ein Produkt zu schaffen, das den höchsten Anforderungen gerecht wird.



ZENTRALHEIZUNGSBETRIEB

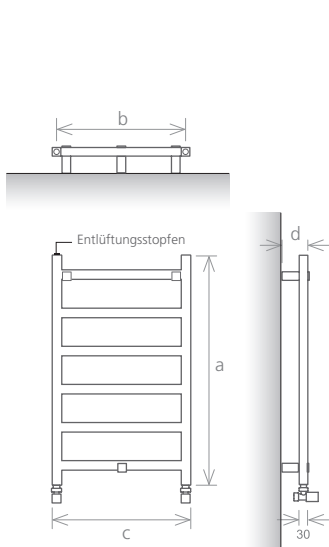

ELEKTROBETRIEB II

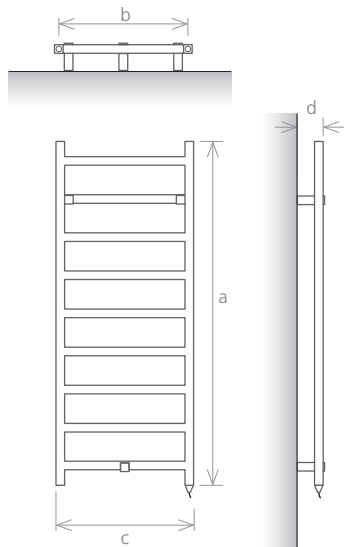

MATERIAL Edelstahl

OBERFLÄCHE



POLIERT



GEBÜRSTET

TITANBESCHICHTET *



ALTGOLD



GOLD



KUPFER

ZUBEHÖR



MIMOO
SWITCH



DOMOTIC
TOUCH

ELEKTROBETRIEB IV

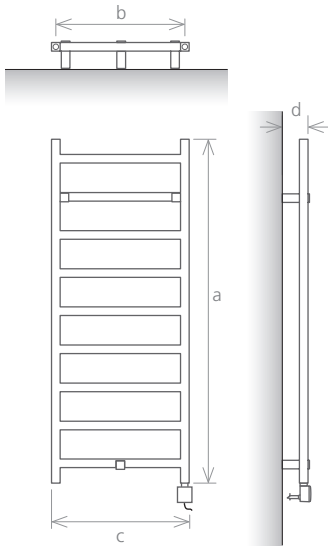

MISCHBETRIEB MIT HEIZPATRONE V

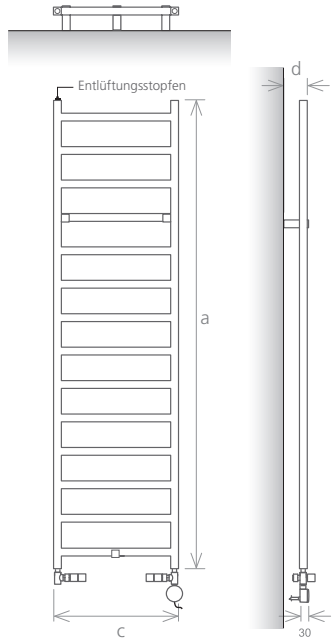

Modell		Q 800E	Q 800L	Q 1200E	Q 1200L	Q 1800E	Q 1800L
hauter (mm)	a	800	800	1200	1200	1800	1800
Nabenabstand (mm)	b	450	500	450	500	450	500
Gesamtbreite (mm)	c	480	530	480	530	480	530
Tiefe (mm)	d	90	90	90	90	90	90
Füllvolumen (l)		2,8	3,1	4,0	4,6	6,9	7,4
Zentralhgz.betr. (W)		250	296	360	438	642	689
El. Leistung (W)		300	300	600	600	1000	1000

STEEL STYLE

BADHEIZKÖRPER

Die Farbe und die Struktur geben dem traditionellen Handtuchwärmer Steel Style eine moderne Note.

Zusätzlich zu seiner dekorativen Wirkung lässt er sich als Elektrobetrieb einfach als Heizlösung im Badambiente integrieren.





MATERIAL C-stahl

OBERFLÄCHE



SCHWARZ
TEXTURIERT



WEISS

ZUBEHÖR



MIMOO
SWITCH



DOMOTIC
TOUCH

ZENTRALHEIZUNGSBETRIEB

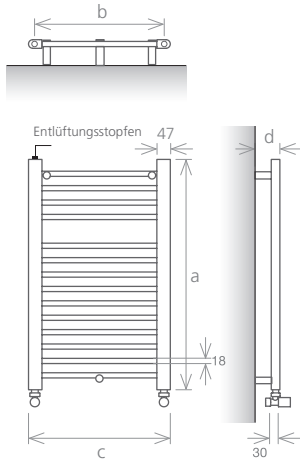

ELEKTROBETRIEB V

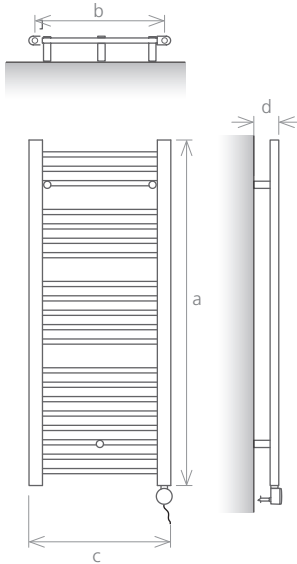

MISCHBETRIEB MIT HEIZPATRONE II

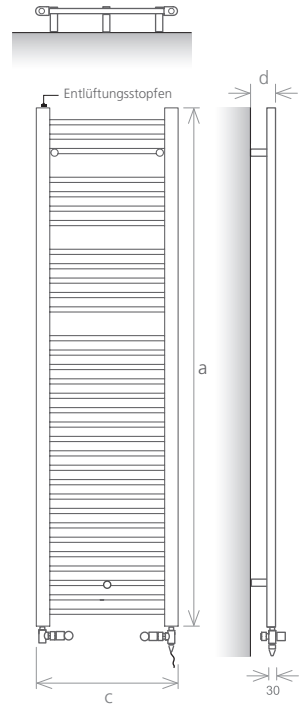

Modell		F 800E	F 800L	F 1200E	F 1200L	F 1800E	F 1800L
Höhe (mm)	a	800	800	1200	1200	1800	1800
Nabenabstand (mm)	b	450	500	450	500	450	500
Gesamtbreite (mm)	c	492	542	492	542	492	542
Tiefe (mm)	d	87	87	87	87	87	87
Füllvolumen (l)		2,5	2,5	3,6	3,7	5,6	5,9
Zentralhgz.betr. (W)		221	234	323	353	497	547
El. Leistung (W)		300	300	600	600	1000	1000

WENN SIE NICHT IDENTIFIZIERT DIE POSITION VOM ELEKTRISCHE HEIZPATRONE ,
DER ELEKTRISCHE HEIZPATRONE IST INSTALLIERT IN DIE RECHTS
UNTERSEITE VOM HEIZKÖRPER.

Sonderfarben nach RAL (Bestätigung erforderlich)

Standardfarbe Weiß (RAL 9016)

REWIND COLLECTION

...the perfect union between the old and the new...

EMPRESS	108
OLD BEAUTY	114
REMIND	120
FLOOR REMIND	124
RETRO SPECIAL	130
OLD GRACE	136
ROYALTY	140

Empress

BADHEIZKÖRPER

Bei dem Entwurf des Badheizkörpers Empress stand die Neuinterpretation alter Stile im Vordergrund. Erhältlich aus gebürstetem oder poliertem Edelstahl in den Ausführungen Gold oder Altgold als Warmwasser- oder Elektrobetrieb (mit verdeckter Heizpatrone).







ZENTRALHEIZUNGSBETRIEB

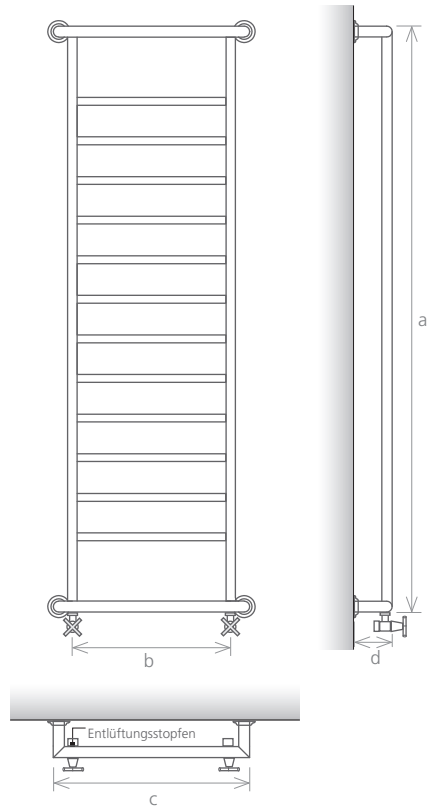

HINWEIS: Für die Modell ab 800mm Höhe mit Heizpatrone II, der erste Rohr heiß nicht.

MATERIAL Edelstahl

OBERFLÄCHE



POLIERT



GEBÜRSTET

TITANBESCHICHTET *



ALTGOLD



GOLD



KUPFER

ZUBEHÖR



MIMOO
SWITCH



DOMOTIC
TOUCH

ELEKTROBETRIEB MIT VERDECKTER
HEIZPATRONE II

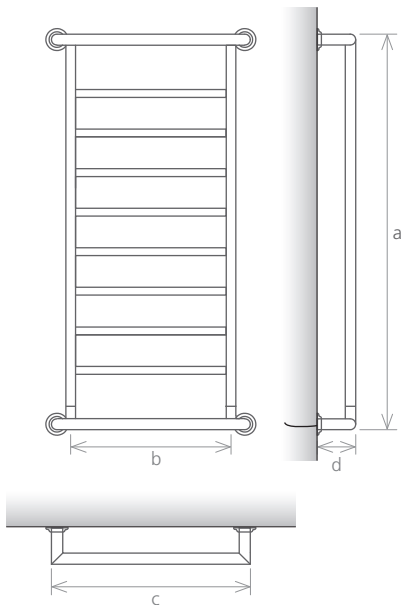

MISCHBETRIEB MIT HEIZPATRONE V

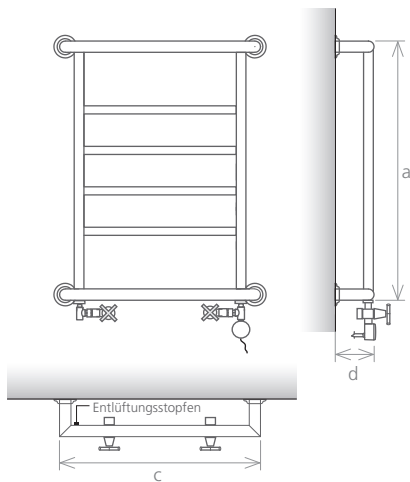

HINWEIS: Für die Modell ab 800mm Höhe mit Heizpatrone II, der erste Rohr heiß nicht.

Modell		E 800E	E 800L	E 1200E	E 1200L	E 1800E	E 1800L
Höhe (mm)	a	800	800	1200	1200	1800	1800
Nabenabstand (mm)	b	450	500	450	500	450	500
Gesamtbreite (mm)	c	570	620	570	620	570	620
Tiefe (mm)	d	120	120	120	120	120	120
Füllvolumen (l)		2,22	2,29	3,27	3,41	4,49	4,70
Zentralhzg.betr. (W)		200	206	294	307	404	423
El. Leistung (W)		300	300	600	600	1000	1000

Old Beauty

BADHEIZKÖRPER

Die Gestaltung des Badheizkörpers Oold Beauty stand unter dem Motto der modernen Interpretation von Klassikern.

Erhältlich aus gebürstetem oder poliertem Edelstahl in den Ausführungen Gold oder Altgold als Warmwasser- oder Elektrobetrieb (mit verdeckter Heizpatrone).







ZENTRALHEIZUNGSBETRIEB

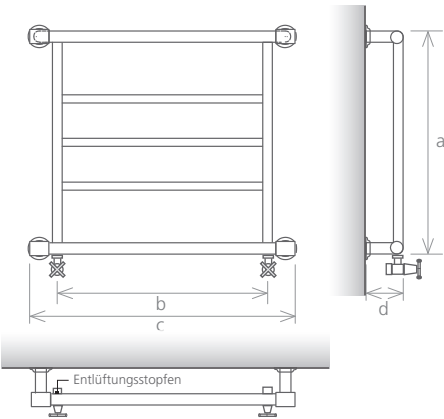

ELEKTROBETRIEB MIT VERDECKTER HEIZPATRONE II

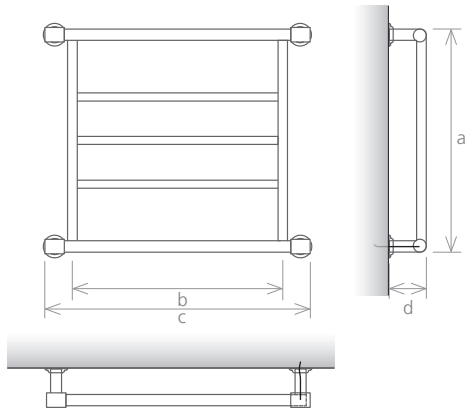

MATERIAL Edelstahl

OBERFLÄCHE



POLIERT



GEBÜRSTET

TITANBESCHICHTET *



ALTGOLD



GOLD



KUPFER

ZUBEHÖR



MIMOO
SWITCH



DOMOTIC
TOUCH

MISCHBETRIEB MIT HEIZPATRONE V

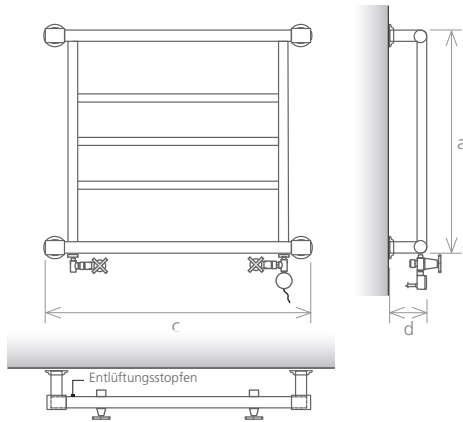

Modell		OB 800
Höhe (mm)	a	690
Nabenabstand (mm)	b	650
Gesamtbreite (mm)	c	820
Tiefe (mm)	d	120
Füllvolumen (l)		2,61
Zentralhgz.betr. (W)		235
El. Leistung (W)		600

Remind

BADHEIZKÖRPER

Aus Leidenschaft für klassisches Design und Vintage entstand der Remind mit seinem einzigartigen Stil: eine Fusion aus modernem Interieur und dem Charme früherer Zeiten. Erhältlich aus Edelstahl in den Ausführungen gebürstet, poliert, Gold oder Altgold als Warmwasser- oder Elektrobetrieb (mit verdeckter Heizpatrone).





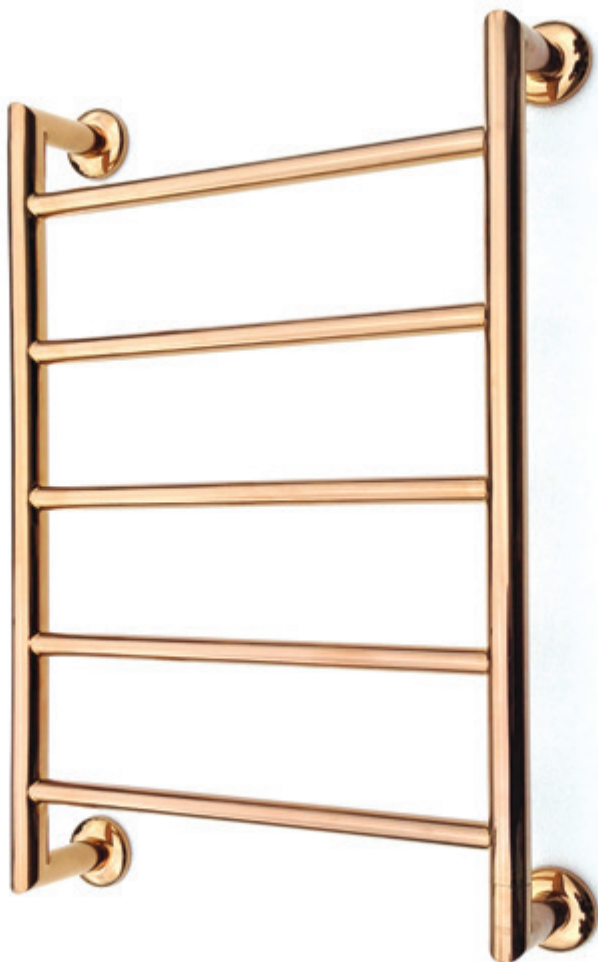

Edelstahl Gelbgold

Elektrobetrieb mit verdeckter Heizpatrone II



MATERIAL Edelstahl

OBERFLÄCHE



POLIERT



GEBÜRSTET

TITANBESCHICHTET *



ALTGOLD



GOLD



KUPFER

ZUBEHÖR



MIMOO
SWITCH



DOMOTIC
TOUCH

ZENTRALHEIZUNGSBETRIEB

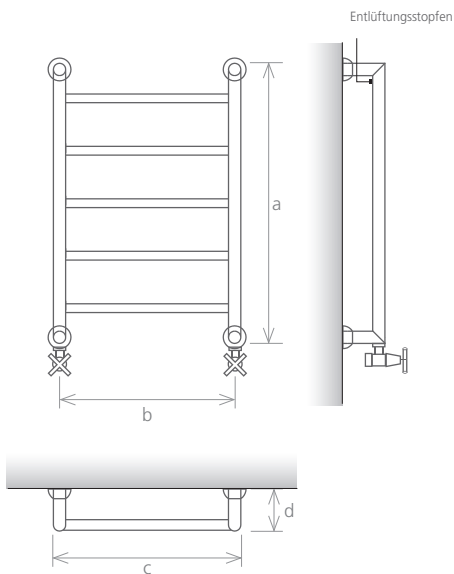

ELEKTROBETRIEB MIT VERDECKTER HEIZPATRONE II

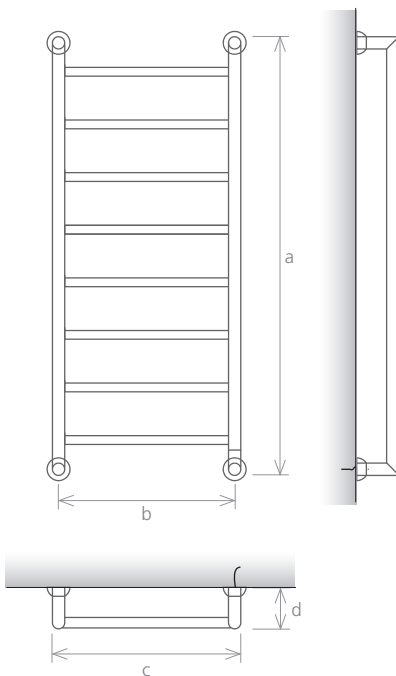

Modell		R 800E	R 800L	R 1200E	R 1200L	R 1800E	R 1800L
Höhe (mm)	a	800	800	1250	1250	1850	1850
Nabenabstand (mm)	b	450	500	450	500	450	500
Gesamtbreite (mm)	c	485	535	485	535	485	535
Tiefe (mm)	d	120	120	120	120	120	120
Füllvolumen (l)		1,84	1,93	2,90	3,03	4,31	4,51
Zentralhgz.betr. (W)		165	174	261	272	387	405
El. Leistung (W)		300	300	600	600	1000	1000

Floor Remind

BADHEIZKÖRPER

Funktionalität, Komfort und Eleganz sind die Eigenschaften, die mit dem Badheizkörper Floor Remind assoziiert werden, der eine flexible Platzierung ermöglicht.



ZENTRALHEIZUNGSBETRIEB

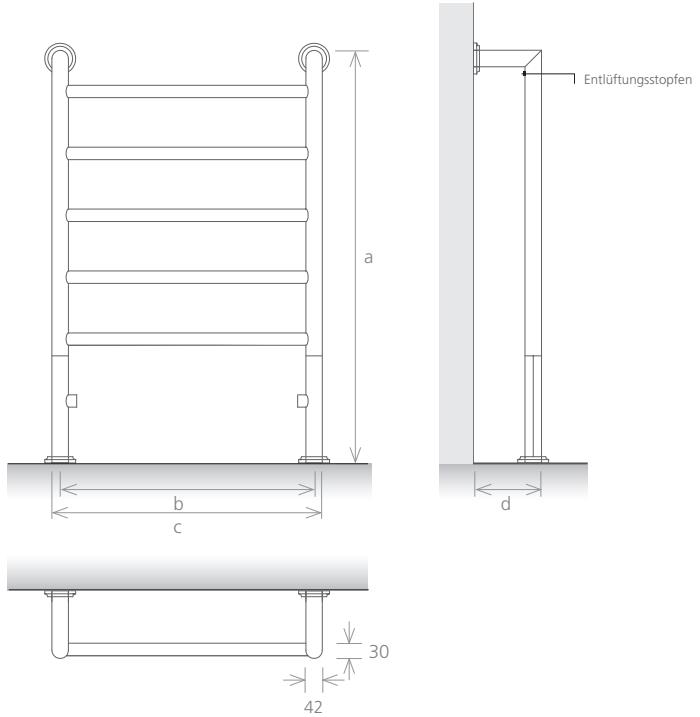

MATERIAL Edelstahl

OBERFLÄCHE



POLIERT



GEBÜRSTET

TITANBESCHICHTET *



ALTGOLD



GOLD



KUPFER

ZUBEHÖR



MIMOO
SWITCH



DOMOTIC
TOUCH

ELEKTROBETRIEB MIT VERDECKTER
HEIZPATRONE II

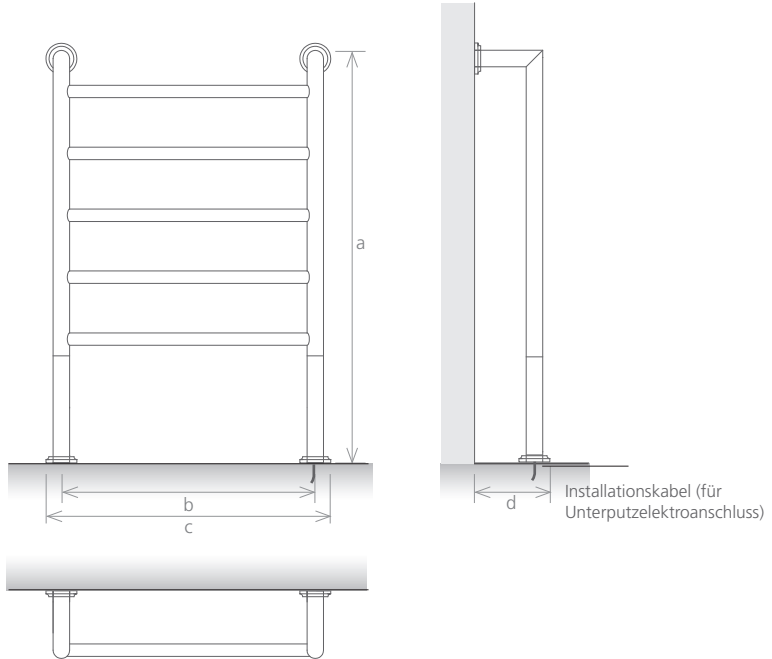

Modell		FR 1000	FR 1200	FR 1400
Höhe (mm)	a	1000	1200	1400
Nabenabstand (mm)	b	600	600	600
Gesamtbreite (mm)	c	642	642	642
Tiefe (mm)	d	140	140	140
Füllvolumen (l)		3,69	4,26	5,17
Zentralhgz.betr. (W)		332	398	465
El. Leistung (W)		600	600	1000

Retro Special

BADHEIZKÖRPER





Elektrobetrieb mit verdeckter Heizpatrone II

MATERIAL Edelstahl / C-Stahl

OBERFLÄCHE



POLIERT



GEBÜRSTET



SCHWARZ
TEXTURIERT



WEISS

TITANBESCHICHTET *



ALTGOLD



GOLD



KUPFER

ELEKTROBETRIEB IV / V

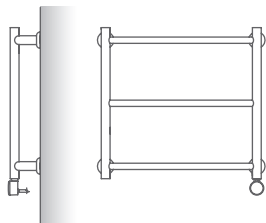

ELEKTROBETRIEB IV / V

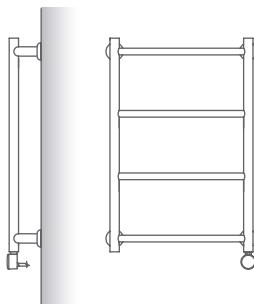

ELEKTROBETRIEB II

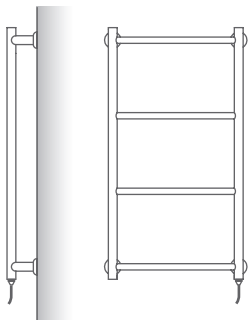

ELEKTROBETRIEB IV / V

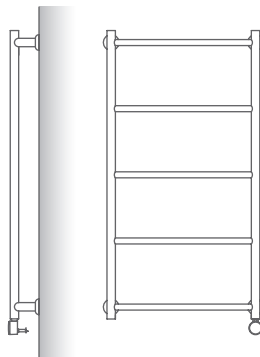

ZUBEHÖR



MIMOO
SWITCH



DOMOTIC
TOUCH

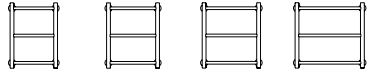

Modell	RE600 400	RE600 450	RE600 500	RE600 600
Höhe (mm)	600	600	600	600
Nabenabstand (mm)	400	450	500	600
Gesamtbreite (mm)	435	485	535	635
Tiefe (mm)	90	90	90	90
Füllvolumen (l)	1,35	1,41	1,47	1,58
Zentralhzg.betr. (W)	101	106	111	122
El. Leistung (W)	150	150	150	200

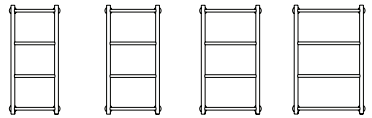

Modell	RE1000400	RE1000450	RE1000500	RE1000600
Höhe (mm)	1000	1000	1000	1000
Nabenabstand (mm)	400	450	500	600
Gesamtbreite (mm)	435	485	535	635
Tiefe (mm)	90	90	90	90
Füllvolumen (l)	2,12	2,2	2,28	2,43
Zentralhzg.betr. (W)	154	161	168	182
El. Leistung (W)	300	300	300	300

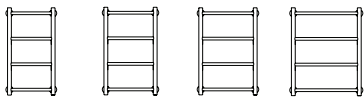

RE800 400	RE800 450	RE800 500	RE800 600	Modell
800	800	800	800	(mm) Höhe
400	450	500	600	(mm) Nabenabstand
435	485	535	635	(mm) Gesamtbreite
90	90	90	90	(mm) Tiefe
1,67	1,73	1,79	1,9	(l) Füllvolumen
120	126	131	142	(W) Zentralhgz.betr.
200	200	200	200	(W) El. Leistung

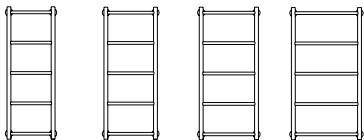

RE1200400	RE1200450	RE1200500	RE1200600	Modell
1200	1200	1200	1200	(mm) Höhe
400	450	500	600	(mm) Nabenabstand
435	485	535	635	(mm) Gesamtbreite
90	90	90	90	(mm) Tiefe
2,45	2,52	2,6	2,75	(l) Füllvolumen
174	181	188	202	(W) Zentralhgz.betr.
300	300	300	300	(W) El. Leistung

Old Grace

BADHEIZKÖRPER

Als Neuinterpretation verschiedener Stile vergangener Zeiten entstand der Badheizkörper Old Grace, der sich sich insbesondere durch seine spiegelartige Oberfläche von anderen Modellen abhebt. Erhältlich aus poliertem oder gebürstetem Edelstahl als Elektro- oder Warmwasserbetrieb.



ZENTRALHEIZUNGSBETRIEB

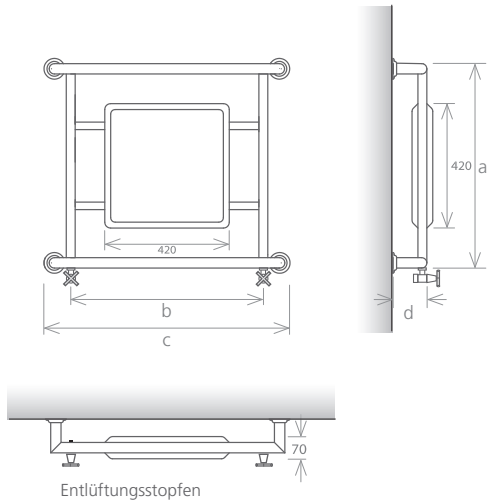

MATERIAL Edelstahl

OBERFLÄCHE



POLIERT



GEBÜRSTET

TITANBESCHICHTET *



ALTGOLD



GOLD



KUPFER

ZUBEHÖR



MIMOO
SWITCH



DOMOTIC
TOUCH

ELEKTROBETRIEB MIT VERDECKTER
HEIZPATRONE II

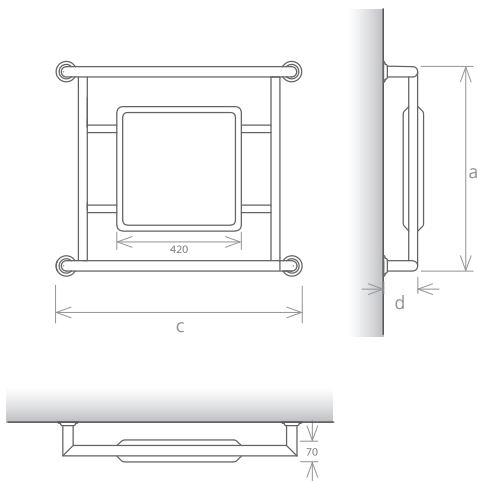

MISCHBETRIEB MIT HEIZPATRONE V

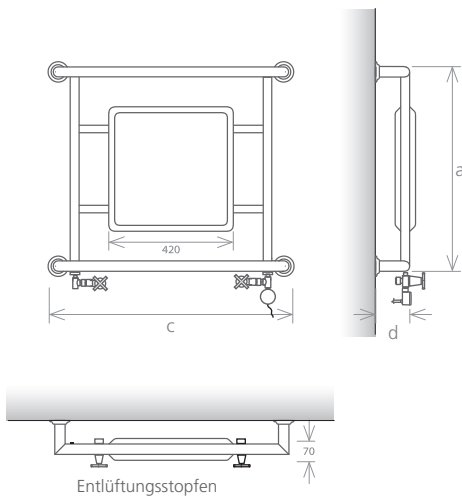

Modell	OG 800
Höhe (mm) a	690
Nabenabstand (mm) b	650
Gesamtbreite (mm) c	850
Tiefe (mm) d	120
Füllvolumen (l)	2,40
Zentralzlg.betr. (W)	390
El. Leistung (W)	600

Royalty

RADIATEUR

Die kühnen und kreativen Linien spiegeln die Lebendigkeit und Originalität des Bodenheizkörpers Royalty wider.
Erhältlich als Elektro- oder Warmwasserbetrieb.



ZENTRALHEIZUNGSBETRIEB

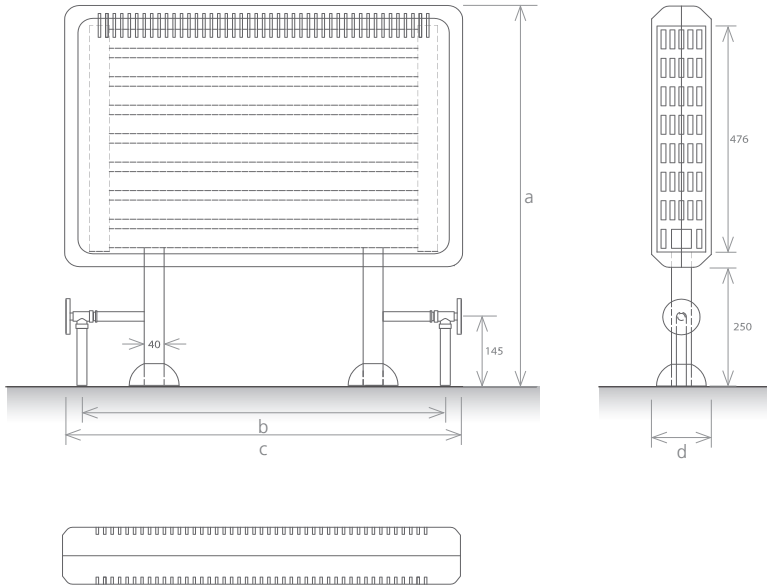

MATERIAL Edelstahl / C-Stahl

OBERFLÄCHE



POLIERT



GEBÜRSTET



SCHWARZ
TEXTURIERT



WEISS

TITANBESCHICHTET *



ALTGOLD



GOLD



KUPFER



Zentralheizungsbetrieb

ZUBEHÖR



MIMOO
SWITCH



DOMOTIC
TOUCH

Modell	RO 800
Höhe (mm) a	800
Nabenabstand (mm) b	730
Gesamtbreite (mm) c	800
Tiefe (mm) d	120
Füllvolumen (l)	14,2
Zentralhgz.betr. (W)	2188
El. Leistung (W)	2000

WENN SIE NICHT IDENTIFIZIERT DIE POSITION VOM ELEKTRISCHE HEIZPATRONE ,
DER ELEKTRISCHE HEIZPATRONE IST INSTALLIERT IN DIE RECHTS
UNTERSEITE VOM HEIZKÖRPER.

Sonderfarben nach RAL (Bestätigung erforderlich)

Standardfarbe Weiß (RAL 9016)

NEW COLLECTION

moments of pure comfort for your bathroom

NEW SLIM	146
NEW SQUARE	150
NEW Q	154

NEW SLIM

BADHEIZKÖRPER

Der New Slim besticht durch seine schlichte Eleganz und raffinierte Form. Eine einfache Möglichkeit, ein ruhiges und komfortables Badambiente zu schaffen.

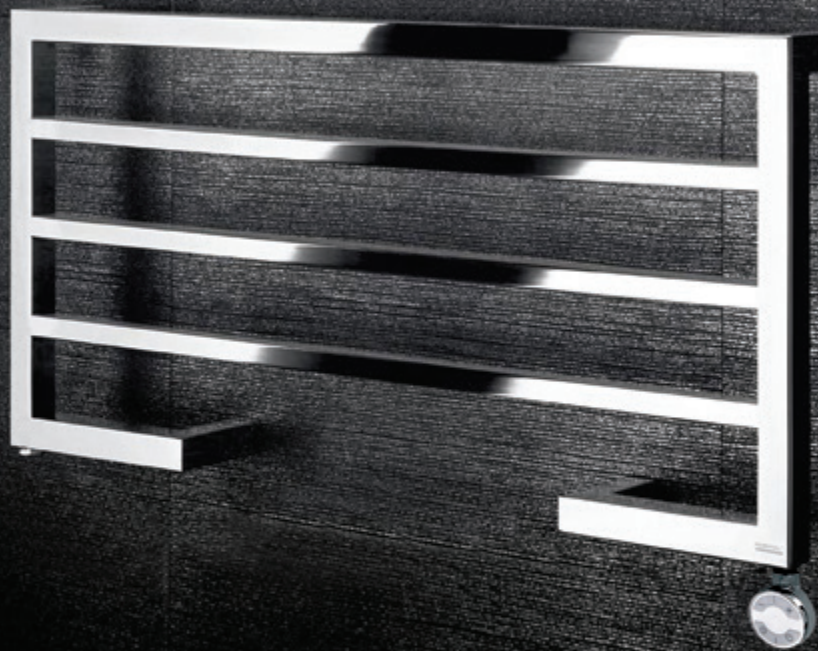

ZENTRALHEIZUNGSBETRIEB

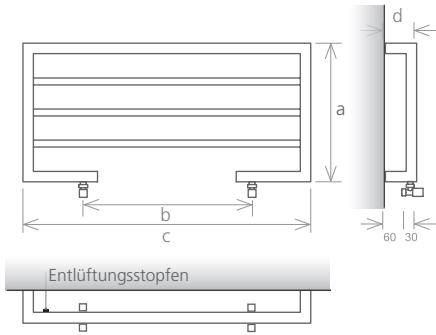

ELEKTROBETRIEB IV / V

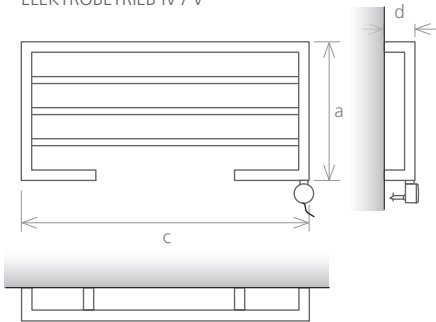

MISCHBETRIEB MIT HEIZPATRONE V

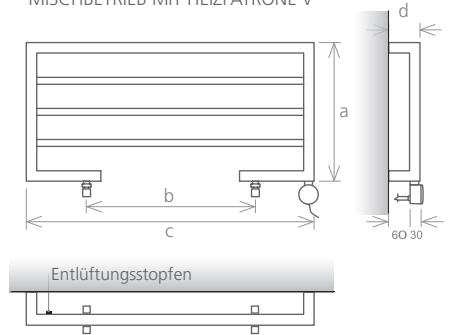

MATERIAL Edelstahl / C-Stahl

OBERFLÄCHE



POLIERT



GEBÜRSTET



SCHWARZ
TEXTURIERT



WEISS



RAL FARBEN

ZUBEHÖR



MIMOO
SWITCH



DOMOTIC
TOUCH



Zentralheizungsbetrieb

Modell	Zentralhgz.betr.		Elektrob.
	NS 400 E	NS 400 L	NS 400
Höhe (mm) a	400	400	400
Nabenabstand (mm) b	450	500	-
Gesamtbreite (mm) c	830	830	830
Tiefe (mm) d	90	90	90
Füllvolumen (l)	2,1	2,1	2,1
Zentralhgz.betr. (W)	242	242	-
El. Leistung (W)	-	-	200

NEW SQUARE

BADHEIZKÖRPER

Mit Regalen aus Corian® sorgt der New Square für mehr Funktionalität und Komfort in Ihrem Bad und stellt ein neues Konzept für die Badheizkörper dar. Geradlinig und von schlichter Eleganz ist er als Elektro- oder Warmwasserbetrieb erhältlich.



ZENTRALHEIZUNGSBETRIEB

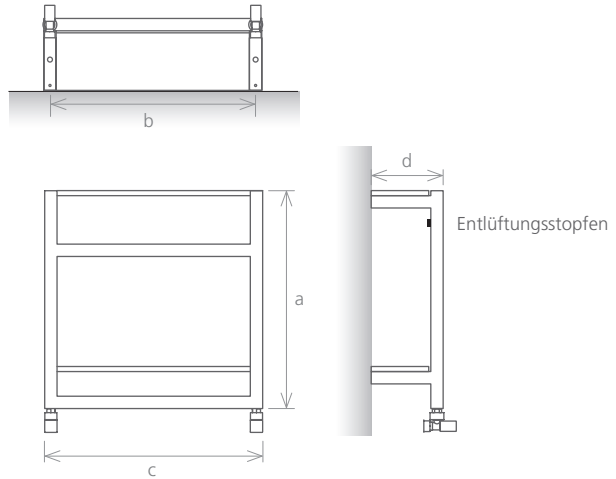

MATERIAL Edelstahl / C-Stahl

OBERFLÄCHE



POLIERT



GEBÜRSTET



SCHWARZ
TEXTURIERT



WEISS



RAL FARBEN

ZUBEHÖR



MIMOO
SWITCH



DOMOTIC
TOUCH

ELEKTROBETRIEB II

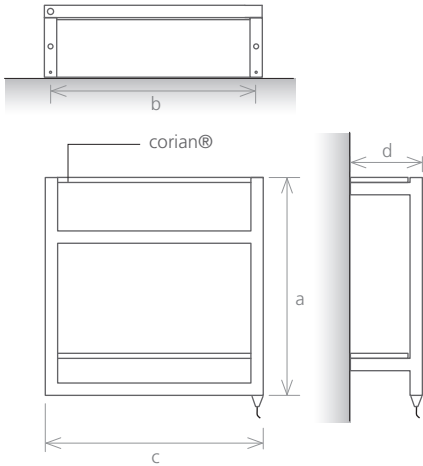

ELEKTROBETRIEB IV / V

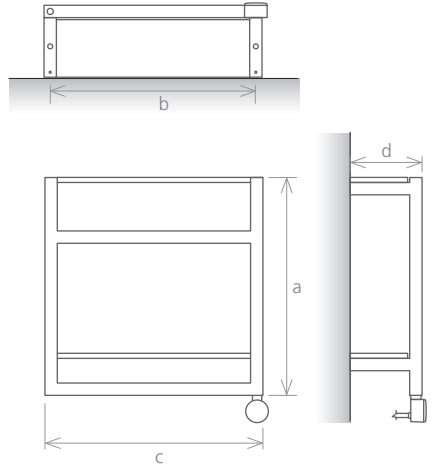

Modell	Zentralhgz.betr.		Elektrob.
	NSQ 530E	NSQ 530L	NSQ 530
Höhe (mm) a	530	530	530
Nabenabstand (mm) b	450	500	-
Gesamtbreite (mm) c	530	530	530
Tiefe (mm) d	175	175	175
Füllvolumen (l)	1,1	1,1	1,1
Zentralhgz.betr. (W)	98	98	-
El. Leistung (W)	-	-	200

NEW Q

BADHEIZKÖRPER

Design, Farbe und Funktionalität bilden die perfekte Kombination und waren ausschlaggebend bei der Gestaltung des Handtuchheizkörpers New Q. Ein flexibler Heizkörper mit detailliertem Design auf matter Oberfläche in kräftigen Farbtönen.





MATERIAL Edelstahl / C-Stahl

OBERFLÄCHE



POLIERT



GEBÜRSTET



SCHWARZ
TEXTURIERT



WEISS



RAL FARBEN

ZUBEHÖR



MIMOO
SWITCH



DOMOTIC
TOUCH

ZENTRALHEIZUNGSBETRIEB

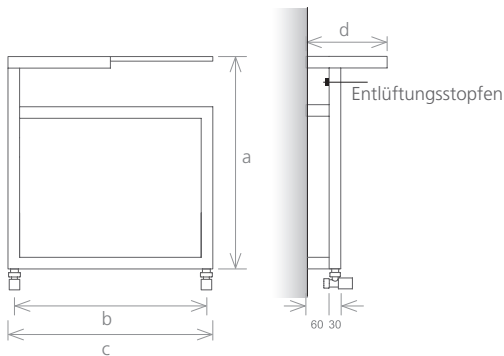

ELEKTROBETRIEB II

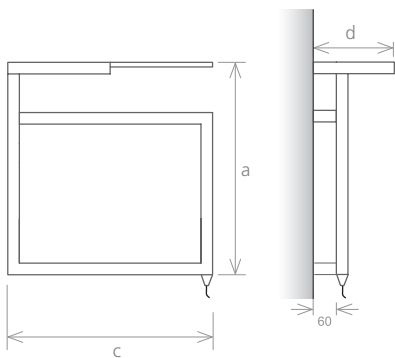

ELEKTROBETRIEB IV / V

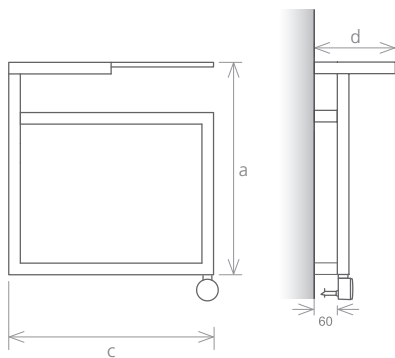

		Zentralhgz.betr.		Elektrob.
Modell		NQ 550E	NQ 550L	NQ 550
Höhe (mm)	a	550	550	550
Nabenabstand (mm)	b	450	500	-
Gesamtbreite (mm)	c	530	530	530
Tiefe (mm)	d	210	210	210
Füllvolumen (l)		0,4	0,4	0,4
Zentralhgz.betr. (W)		36	36	-
El. Leistung (W)		-	-	200

WENN SIE NICHT IDENTIFIZIERT DIE POSITION VOM ELEKTRISCHE HEIZPATRONE ,
DER ELEKTRISCHE HEIZPATRONE IST INSTALLIERT IN DIE RECHTS
UNTERSEITE VOM HEIZKÖRPER.

Sonderfarben nach RAL (Bestätigung erforderlich)

Standardfarbe Weiß (RAL 9016)

BASIC LINE

the simple line

BASIC LINE 160

BASIC LINE

BADHEIZKÖRPER

Der schlichte und praktische Handtuchheizkörper Basic Line sorgt dafür, dass das Badezimmer und die Handtücher immer mollig warm sind und ist damit eine preiswerte Lösung für Ihren Bad-Komfort.

Basic Line ist in Edel- oder C-Stahl als Zentralheizungs-, Elektro- oder Mischbetrieb erhältlich.





MATERIAL Edelstahl / C-Stahl

OBERFLÄCHE



POLIERT



GEBÜRSTET



SCHWARZ
TEXTURIERT



WEISS



RAL FARBEN

ZUBEHÖR



MIMOO
SWITCH



DOMOTIC
TOUCH



ZENTRALHEIZUNGSBETRIEB

ELEKTROBETRIEB II

ELEKTROBETRIEB III

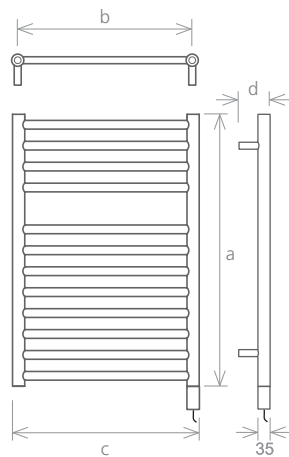
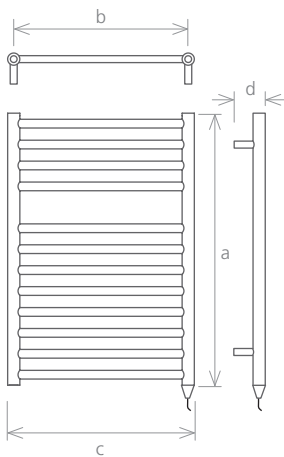
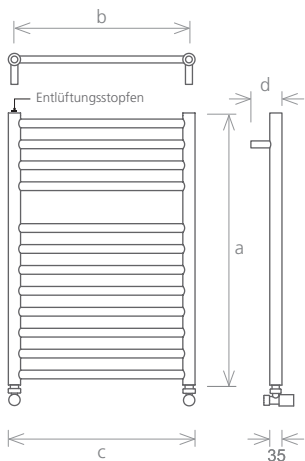

Modell		BL800E	BL800L	BL800XL	BL1200E	BL1200L	BL1200XL
Höhe (mm)	a	780	780	780	1200	1200	1200
Nabenabstand (mm)	b	450	500	600	450	500	600
Gesamtbreite (mm)	c	485	535	635	485	535	635
Tiefe (mm)	d	90	90	90	90	90	90
Füllvolumen (l)		2,90	3,16	3,68	4,19	4,56	5,29
Zentralhzg.betr. (W)		259,1	282,2	328,5	374,4	407,1	472,7
El. Leistung (W)		300	300	300	600	600	600

VERSION: MISCHBETRIEB

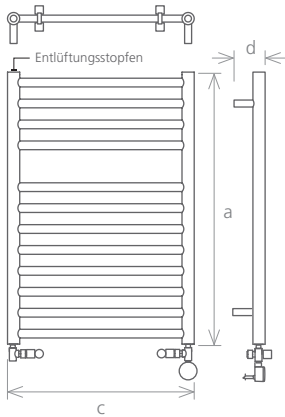

ZENTRALHEIZUNGSBETRIEB

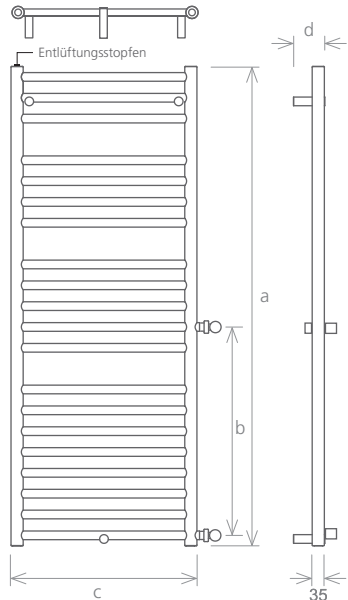

BL1400 IO (in&out) - Seitenanschluss

BL1400E	BL1400L	BL1400XL	BL1400 IO	BL1800E	BL1800L	BL1800XL	Modell
1380	1380	1380	1380	1800	1800	1800	a (mm) Höhe
450	500	600	600	450	500	600	b (mm) Nabenabstand
485	535	635	535	485	535	635	c (mm) Gesamtbreite
90	90	90	90	90	90	90	d (mm) Tiefe
4,90	5,33	6,19	5,33	6,55	7,14	8,30	(l) Füllvolumen
437,8	476,2	553,0	476,2	585,5	637,5	741,7	(W) Zentralhgz.betr.
600	600	600	-	1000	1000	1000	(W) El. Leistung

WENN SIE NICHT IDENTIFIZIERT DIE POSITION VOM ELEKTRISCHE HEIZPATRONE ,
DER ELEKTRISCHE HEIZPATRONE IST INSTALLIERT IN DIE RECHTS
UNTERSEITE VOM HEIZKÖRPER.

Sonderfarben nach RAL (Bestätigung erforderlich)

Standardfarbe Weiß (RAL 9016)

DESIGN COLLECTION

DIAMOND	168
DIAMOND XS	172
ARENA	176
ARENA TABLE	182

DIAMOND

DESIGN-HEIZKÖRPER

DESIGNER: PATRICK PEDROSA

Der Diamond entstand, um den Bedürfnissen nach Heizkörpern gerecht zu werden, die sowohl eine Evolution als auch eine Differenzierung im Raumkonzept darstellen.

Das Besondere an diesem Design-Heizkörper ist seine unregelmäßigen Form, die an einen Diamanten erinnert, sowie seine Farbe und Wärmeleistung.



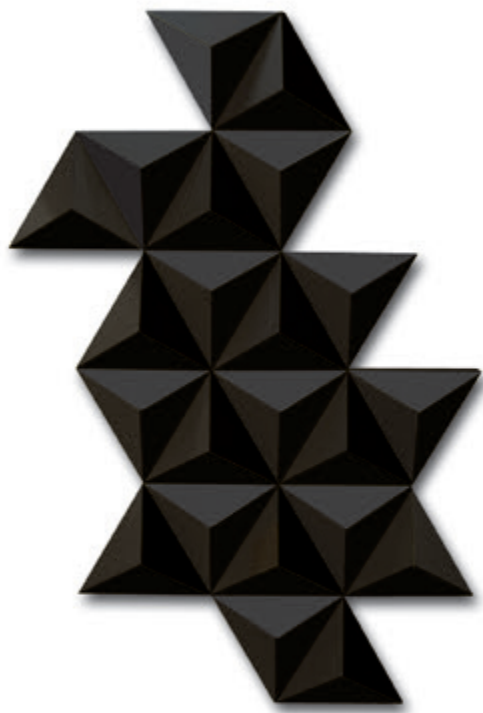

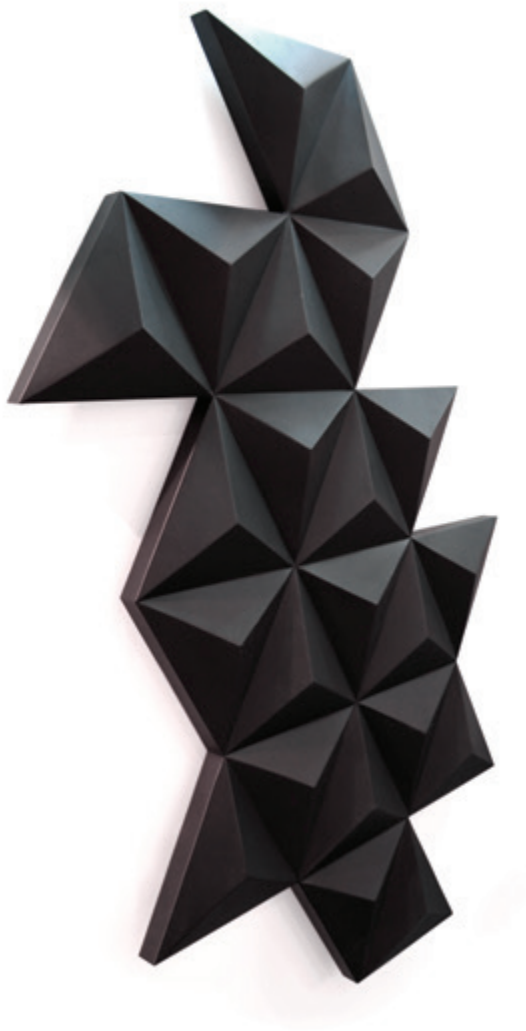



DIAMOND XS

DESIGN-HEIZKÖRPER

DESIGNER: PATRICK PEDROSA

OUTPUT MAX:
2000 WATTS

electric
element
hidden

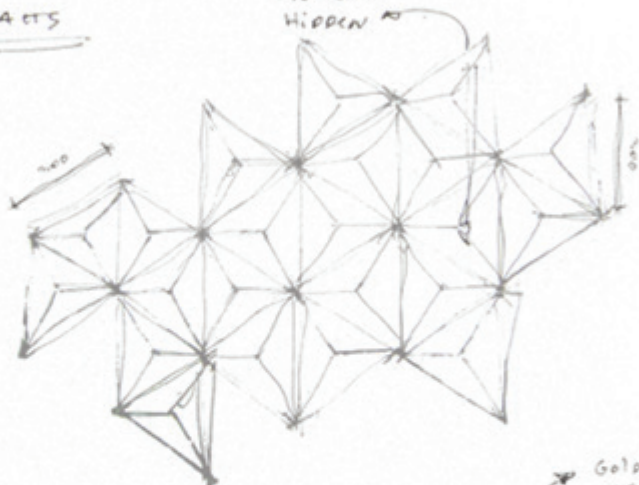

black
white

Gold

Patrick Pedrosa MAY 2011

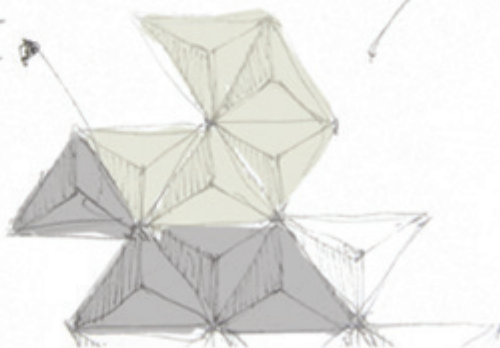

Erste Entwurfsskizze des Diamonds



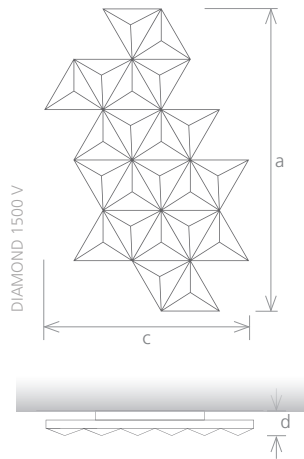
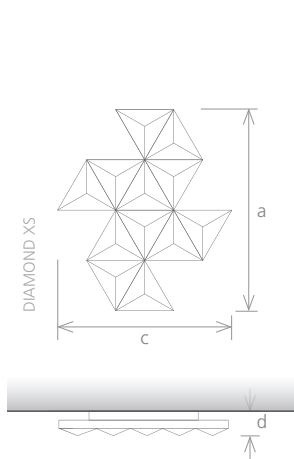

MATERIAL Edelstahl / C-Stahl

OBERFLÄCHE



GEBÜRSTET



SCHWARZ
TEXTURIERT



WEISS



RAL FARBEN

TITANBESCHICHTET *



ALTGOLD



GOLD



KUPFER

ZENTRALHEIZUNGSBETRIEB

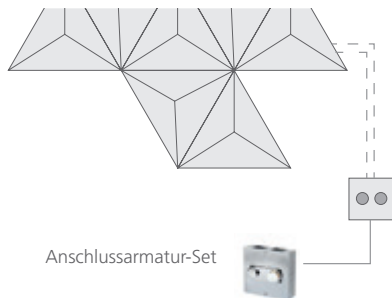

Anschlussarmatur-Set

ELEKTROBETRIEB II

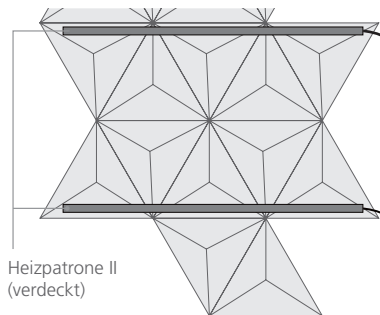

Heizpatrone II
(verdeckt)

ZUBEHÖR



ANSCHLUSS-
ARMATUR-SET



MIMOO
SWITCH



DOMOTIC
TOUCH

Modell		D XS	D 1200H	D 1500V
Höhe (mm)	a	1040	1050	1560
Nabenabstand (mm)	b	50	50	50
Gesamtbreite (mm)	c	900	1560	1050
Tiefe (mm)	d	110	110	110
Füllvolumen (l)		4,75	11,18	11,18
Gewicht (kg)		≈ 35	≈ 75	≈ 75
Zentralhgz.betr. (W)		568	1205	1205
El. Leistung (W)		600-1000	1600-2000	1600-2000

ARENA

DESIGN-HEIZKÖRPER

DESIGNER: PATRICK PEDROSA

Der Arena-Heizkörper bietet eine alternative Heizmethode. Retro-inspiriert eignet er sich als funktionales, flexibles und anpassungsfähiges Dekorelement für alle Räume im Haus.

Durch die Wahl und Kombination von unterschiedlichen Materialien und Oberflächen passt der Arena sich Ihrem persönlichen Stil an.

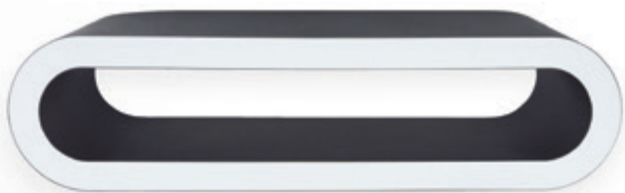

ARENA

DESIGN-HEIZKÖRPER

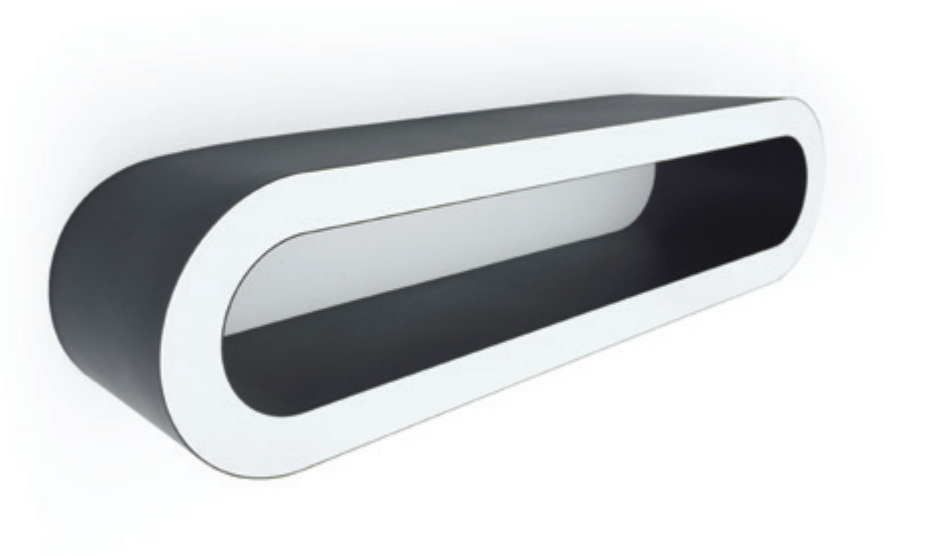

Schwarz texturiert + Weiß



Schwarz texturiert + Weiß



Weiß + poliert



Weiß



Schwarz texturiert

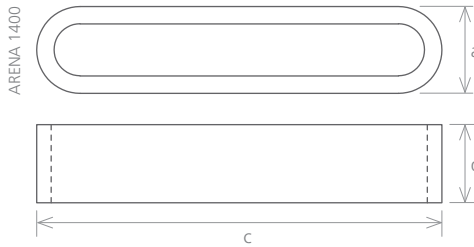
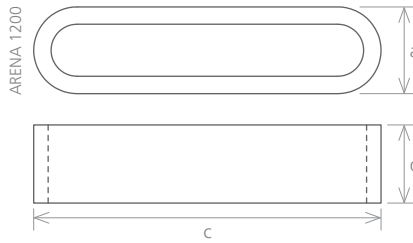
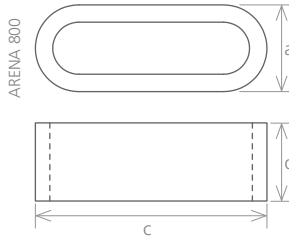

MATERIAL Edelstahl / C-Stahl

OBERFLÄCHE



POLIERT



GEBÜRSTET



SCHWARZ
TEXTURIERT



WEISS



RAL FARBEN



TITANBESCHICHTET *



ALTGOLD



GOLD



KUPFER

ZENTRALHEIZUNGSBETRIEB

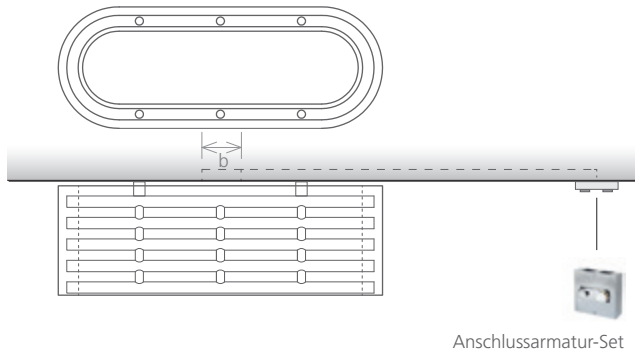

ELEKTROBETRIEB II

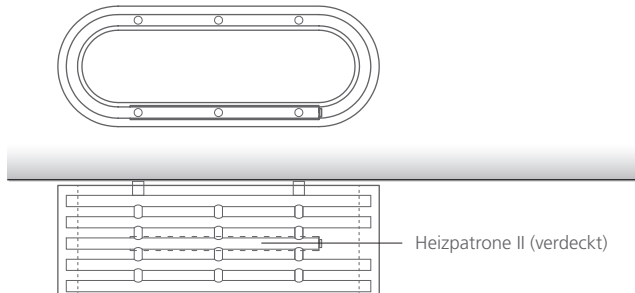

ZUBEHÖR



ANSCHLUSS-
ARMATUR-SET



MIMOO
SWITCH



DOMOTIC
TOUCH

Modell		A 800	A 1200	A 1400
Höhe (mm)	a	300	300	300
Nabenabstand (mm)	b	50	50	50
Gesamtbreite (mm)	c	800	1200	1400
Tiefe (mm)	d	270	270	270
Füllvolumen (l)		5,32	7,78	9,04
Gewicht (kg)		~30	~45	~55
Zentralhgz.betr. (W)		578	801	913
El. Leistung (W)		600	1000	1400

ARENA TABLE

DESIGN-HEIZKÖRPER

DESIGNER: PATRICK PEDROSA

Design + Funktionalität + Einfachheit = Arena Table

Unter diesem Leitgedanken wurde der elektrische Heizkörper Arena Table konzipiert. Verschmelzung von Funktionalität und Design pur zu einem Heizelement für verschiedene Bereiche.

Der Retro-inspirierte Heizkörper lässt sich mit seiner schlichten Eleganz dekorativ in Ihren Wohnraum integrieren.



ELEKTROBETRIEB MIT VERDECKTER HEIZPATRONE II

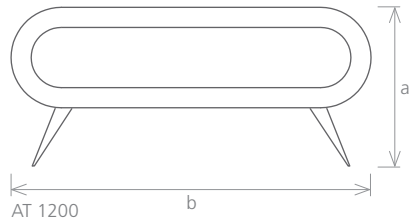
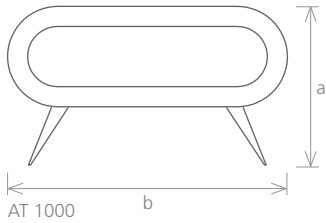

MATERIAL Edelstahl / C-Stahl

OBERFLÄCHE



POLIERT



GEBÜRSTET



SCHWARZ
TEXTURIERT



WEISS



RAL FARBEN

TITANBESCHICHTET *



ALTGOLD



GOLD



KUPFER

VORDERANSICHT

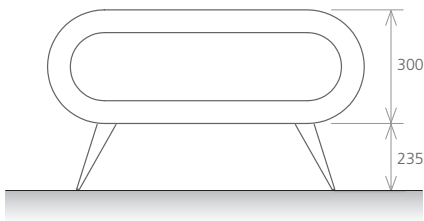

SEITENANSICHT

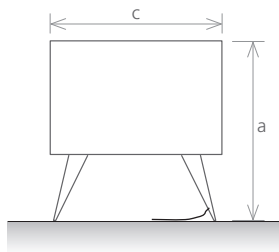

DRAUFSICHT

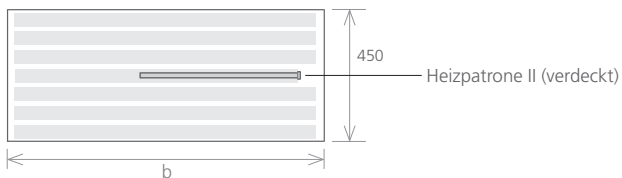

ZUBEHÖR



ANSCHLUSS-
ARMATUR-SET



MIMOO
SWITCH



DOMOTIC
TOUCH

Modell		AT 1000	AT 1200	AT 1400
Höhe (mm)	a	535	535	535
Gesamtbreite (mm)	b	1000	1200	1400
Tiefe (mm)	c	450	450	450
Füllvolumen (l)		7,45	10,89	12,66
Gewicht (kg)		~50	~65	~75
El. Leistung (W)		1000	1500	1500

WENN SIE NICHT IDENTIFIZIERT DIE POSITION VOM ELEKTRISCHE HEIZPATRONE ,
DER ELEKTRISCHE HEIZPATRONE IST INSTALLIERT IN DIE RECHTS
UNTERSEITE VOM HEIZKÖRPER.

Sonderfarben nach RAL (Bestätigung erforderlich)

Standardfarbe Weiß (RAL 9016)

ROOM RADIATORS

CURVE	188
D LIGNE	194
DIVINE	200
LINEAR	206
PLANO MOVE	212
PLANO PURE	218
PLANO PURE ON/OFF	224
PLANO +	226
PLANO	232

CURVE

HEIZKÖRPER

Modern and simple lines. The new and extraordinary design radiator developed by Foursteel® is appropriated for cosmopolitan interior spaces. Available in the electric and central heating version.



CURVE



MATERIAL Edelstahl / C-Stahl

OBERFLÄCHE



POLIERT



GEBÜRSTET



SCHWARZ
TEXTURIERT



WEISS



RAL FARBEN

ZUBEHÖR



ANSCHLUSS-
ARMATUR-SET



MIMOO
SWITCH



DOMOTIC
TOUCH

ELEKTROBETRIEB MIT VERDECKTER HEIZPATRONE II

VORDERANSICHT



Einschaltknopf mit LED
Spannung 230 V

SEITENANSICHT

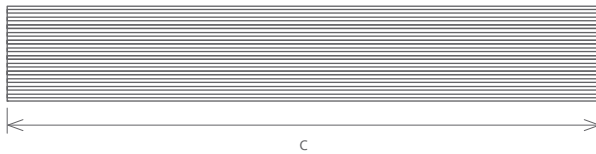
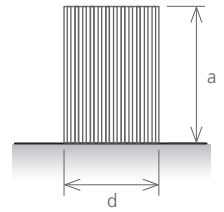

DRAUFSICHT

Modell		C2301000	C2301500	C2302000	C3001000	C3001500	C3002000
Höhe (mm)	a	230	230	230	300	300	300
Gesamtbreite (mm)	b	1000	1500	2000	1000	1500	2000
Tiefe (mm)	c	160	160	160	160	160	160
Füllvolumen (L)		1,3	2,1	2,9	1,3	2,1	2,9
El. Leistung (W)		1600	1800	2000	1600	1800	2000

CURVE



ZENTRALHEIZUNGSBETRIEB

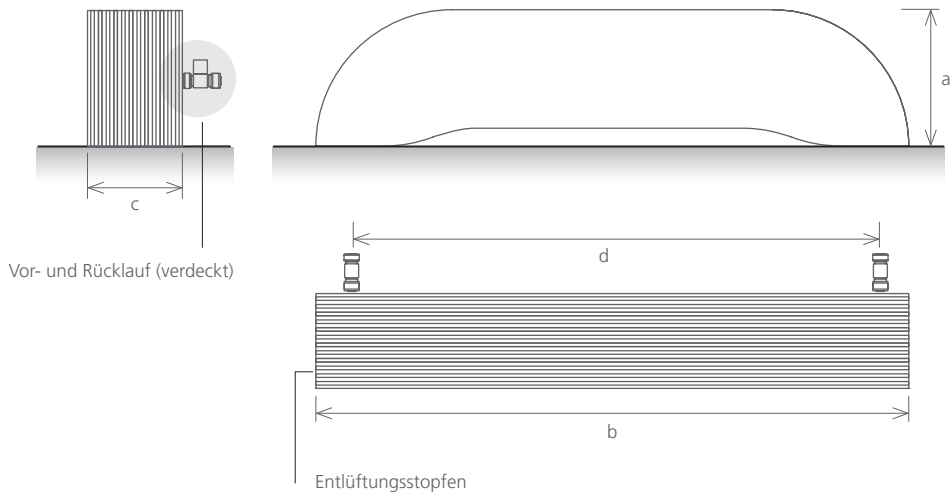

Modell		C2301000	C2301500	C2302000	C3001000	C3001500	C3002000
Höhe (mm)	a	230	230	230	300	300	300
Gesamtbreite (mm)	b	1000	1500	2000	1000	1500	2000
Tiefe (mm)	c	160	160	160	160	160	160
Nabenabstand (mm)	d	800	1300	1800	800	1300	1800
Zentralhgz.betr. (W)		872	1343	1787	1308	2015	2480

D LIGNE

HEIZKÖRPER

Design mit verführerischen und ausgezeichneten Linien. Im Segment von Foursteel's® entwickelten Bodenheizkörpern stellen wir den D Ligne vor. Für elegante und zeitgenössische Räume geeignet. In der elektrischen und in der Zentralheizung Version erhältlich.



D LIGNE



MATERIAL Edelstahl / C-Stahl

OBERFLÄCHE



POLIERT



GEBÜRSTET



SCHWARZ
TEXTURIERT



WEISS



RAL FARBEN



ZUBEHÖR



ANSCHLUSS-
ARMATUR-SET



MIMOO
SWITCH



DOMOTIC
TOUCH

ELEKTROBETRIEB MIT VERDECKTER HEIZPATRONE II

VORDERANSICHT

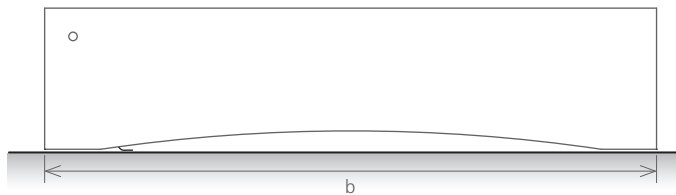

Einschaltknopf mit LED
Spannung 230 V

SEITENANSICHT

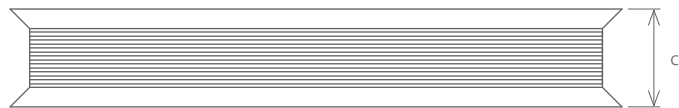
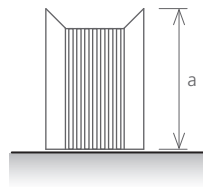

DRAUFSICHT

Modell	DL2301000	DL2301500	DL2302000	DL3001000	DL3001500	DL3002000
Höhe (mm) a	230	230	230	300	300	300
Gesamtbreite (mm) b	1000	1500	2000	1000	1500	2000
Tiefe (mm) c	160	160	160	160	160	160
Füllvolumen (L)	1,4	2,2	3,0	1,4	2,2	3,0
El. Leistung (W)	1600	1800	2000	1600	1800	2000

ZENTRALHEIZUNGSBETRIEB

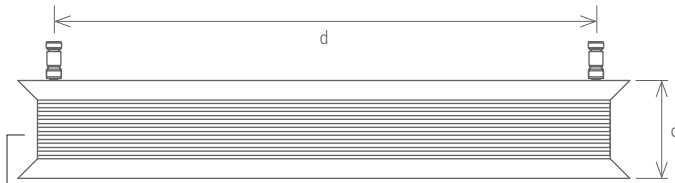
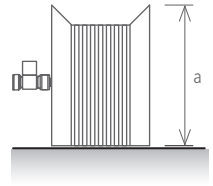
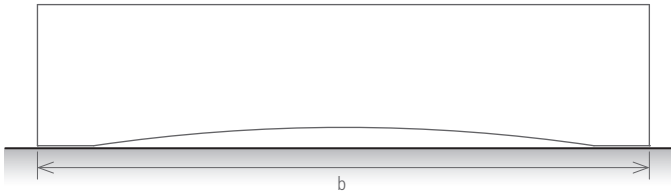

Entlüftungsstopfen

Lösung 1

Lösung 2

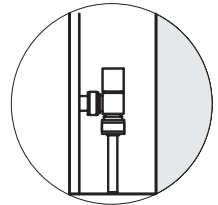
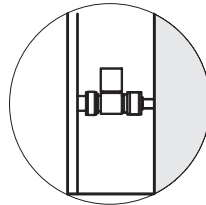

Modell		DL2301000	DL2301500	DL2302000	DL3001000	DL3001500	DL3002000
Höhe (mm)	a	230	230	230	300	300	300
Gesamtbreite (mm)	b	1000	1500	2000	1000	1500	2000
Tiefe (mm)	c	160	160	160	160	160	160
Nabenabstand (mm)	d	880	1380	1880	880	1380	1880
Zentralhgz.betr. (W)		948	1460	1942	1422	2190	2913



DIVINE
HEIZKÖRPER



DIVINE



ELEKTROBETRIEB MIT VERDECKTER HEIZPATRONE II

SEITENANSICHT

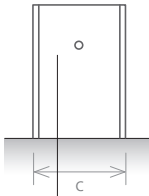

VORDERANSICHT

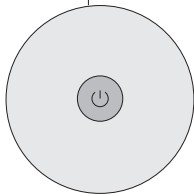
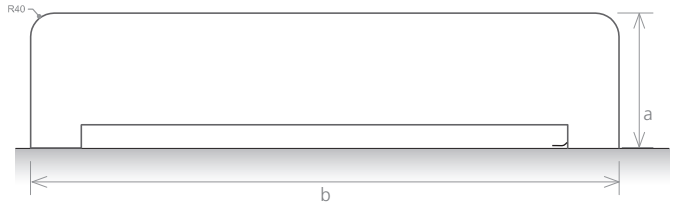

Einschaltknopf mit LED
Spannung 230 V

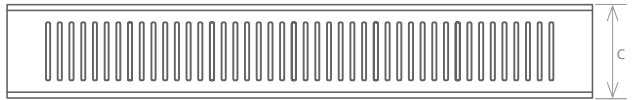

DRAUFSICHT

Modell		DI 1000	DI 1500	DI 2000	DI30 1000	DI30 1500	DI30 2000
Höhe (mm)	a	230	230	230	300	300	300
Gesamtbreite (mm)	b	1000	1500	2000	1000	1500	2000
Tiefe (mm)	c	160	160	160	160	160	160
Füllvolumen (L)		1,4	2,2	3,0	1,4	2,2	3,0
El. Leistung (W)		1600	1800	2000	1600	1800	2000

ZENTRALHEIZUNGSBETRIEB

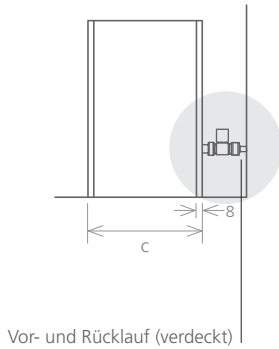

Lösung 1

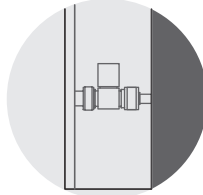

Lösung 2

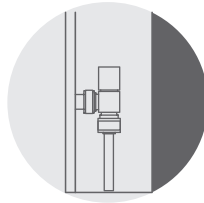

MATERIAL Edelstahl / C-Stahl

OBERFLÄCHE



POLIERT



GEBÜRSTET



SCHWARZ
TEXTURIERT



WEISS



RAL FARBEN

ZUBEHÖR



ANSCHLUSS-
ARMATUR-SET



MIMOO
SWITCH



DOMOTIC
TOUCH

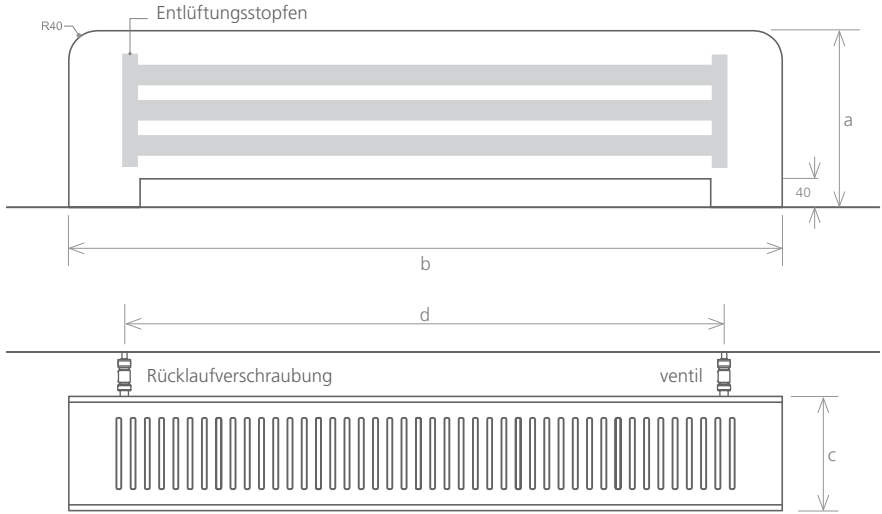

Modell		DI 1000	DI 1500	DI 2000	DI30 1000	DI30 1500	DI30 2000
Höhe (mm)	a	230	230	230	300	300	300
Gesamtbreite (mm)	b	1000	1500	2000	1000	1500	2000
Tiefe (mm)	c	160	160	160	160	160	160
Nabenabstand (mm)	d	880	1380	1880	880	1380	1880
Zentralhgz.betr. (W)		948	1460	1942	1422	2190	2913

LINEAR

HEIZKÖRPER

Der Linear-Raumheizkörper zeichnet sich durch hohe Wärmeleistung und große Anpassungsfähigkeit aus.

Erhältlich aus Karbon- oder Edelstahl in den Ausführungen Weiß, Schwarz texturiert, poliert oder gebürstet.

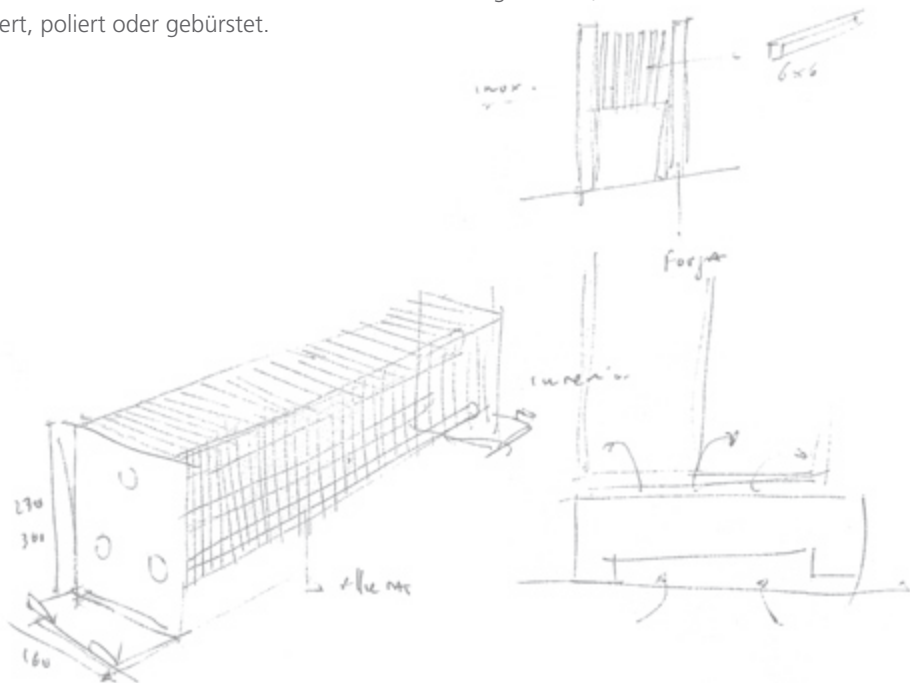





MATERIAL Edelstahl / C-Stahl

OBERFLÄCHE



POLIERT



GEBÜRSTET



SCHWARZ
TEXTURIERT



WEISS



RAL FARBEN



ZUBEHÖR



ANSCHLUSS-
ARMATUR-SET



MIMOO
SWITCH



DOMOTIC
TOUCH

ELEKTROBETRIEB MIT VERDECKTER HEIZPATRONE II

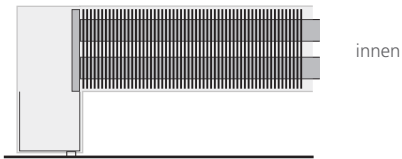
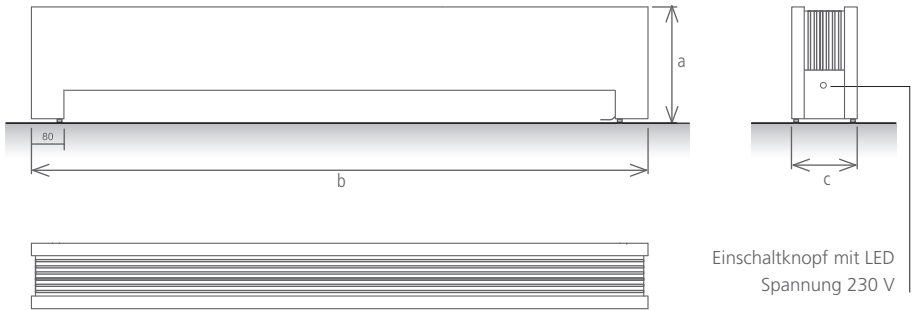

Modell		LE 1000	LE 1500	LE 1000+	LE 1500+	LE 2000+	LE30 1000	LE30 1500	LE30 2000
Höhe (mm)	a	240	240	240	240	240	310	310	310
Gesamtbreite (mm)	b	1000	1500	1000	1500	2000	1000	1500	2000
Tiefe (mm)	c	100	100	160	160	160	160	160	160
Füllvolumen (L)		1,4	2,2	1,4	2,2	3,0	1,4	2,2	3,0
El. Leistung (W)		1600	1800	1600	1800	2000	1600	1800	2000

ZENTRALHEIZUNGSBETRIEB

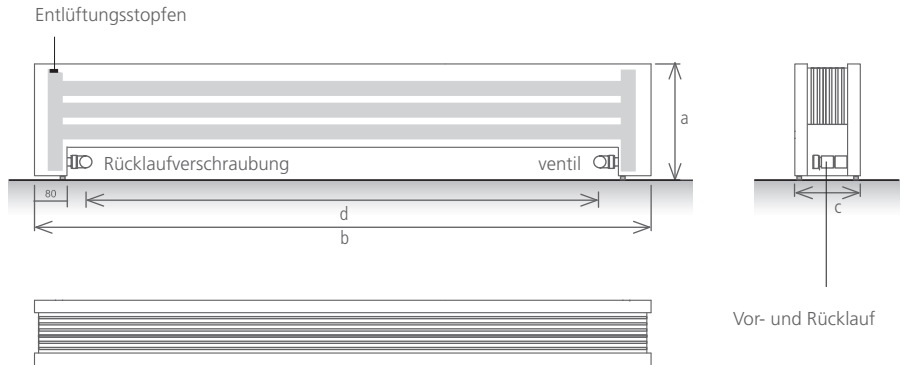

Lösung 1

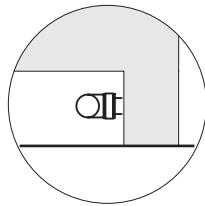

Lösung 2

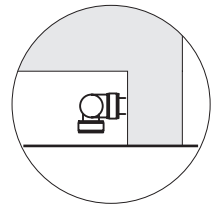

Modell		LC 1000	LC 1500	LC 2000	LC30 1000	LC30 1500	LC30 2000
Höhe (mm)	a	240	240	240	310	310	310
Gesamtbreite (mm)	b	1000	1500	2000	1000	1500	2000
Tiefe (mm)	c	160	160	160	160	160	160
Nabenabstand (mm)	d	-	-	-	-	-	-
Zentralhgz.betr. (W)		948	1460	1942	1422	2190	2913

PLANO MOVE

BADHEIZKÖRPER

Aufgrund seines minimalistischen Konzepts erweist sich der Plano Move als eine neue Lösung für die Klimatisierung Ihres Raumbereiches. Er funktioniert als Handtuchrockner und/oder Heizkörper und passt sich durch verschiedene Größen unterschiedlichen Bereichen an.

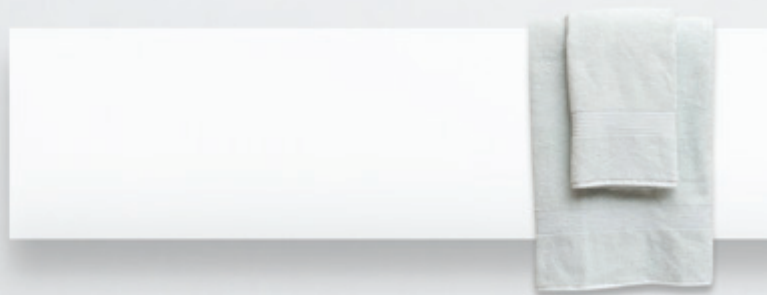



MATERIAL Edelstahl / C-Stahl

OBERFLÄCHE



POLIERT



GEBÜRSTET



SCHWARZ
TEXTURIERT



WEISS



RAL FARBEN

ZUBEHÖR



MIMOO
SWITCH



DOMOTIC
TOUCH



ELEKTROBETRIEB MIT VERDECKTER HEIZPATRONE II

VORDERANSICHT



SEITENANSICHT



HINWEIS: elektrische heizpatrone (heizstab) mit wärmeträgerflüssigkeit

Modell	PM400 800	PM500 800	PM600 800	PM400 1200	PM500 1200	PM600 1200	PM400 1400
Höhe (mm) a	400	500	600	400	500	600	400
Gesamtbreite (mm) c	800	800	800	1200	1200	1200	1400
Tiefe (mm) d	40 / 60 / 90	40 / 60 / 90	40 / 60 / 90	40 / 60 / 90	40 / 60 / 90	40 / 60 / 90	40 / 60 / 90
El. Leistung (W)	300	300	600	600	600	600	300

Modell	PM800 400	PM800 500	PM800 600	PM1200 400	PM1200 500	PM1200 600	PM1400 400
Höhe (mm) a	800	800	800	1200	1200	1200	1400
Gesamtbreite (mm) c	400	500	600	400	500	600	400
Tiefe (mm) d	40 / 60 / 90	40 / 60 / 90	40 / 60 / 90	40 / 60 / 90	40 / 60 / 90	40 / 60 / 90	40 / 60 / 90
El. Leistung (W)	300	300	600	600	600	600	300

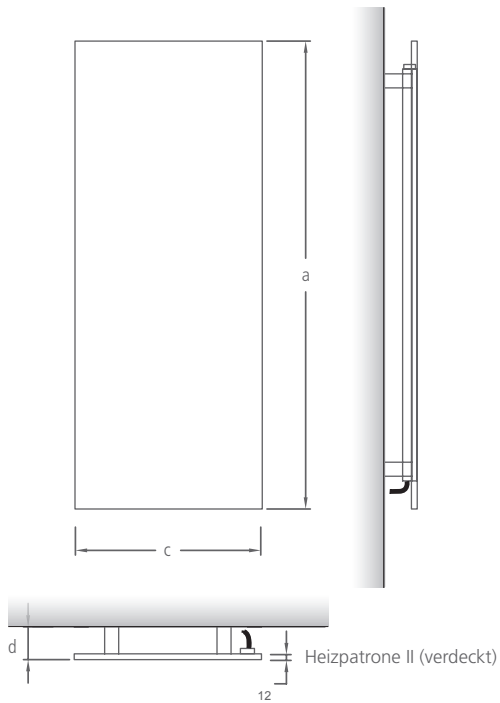

HINWEIS: elektrische heizpatrone (heizstab) mit wärmeträgerflüssigkeit

PM500 1400	PM600 1400	PM400 1800	PM500 1800	PM600 1800	PM400 2000	PM500 2000	PM600 2000
500	600	400	500	600	400	500	600
1400	1400	1800	1800	1800	2000	2000	2000
40 / 60 / 90	40 / 60 / 90	40 / 60 / 90	40 / 60 / 90	40 / 60 / 90	40 / 60 / 90	40 / 60 / 90	40 / 60 / 90
300	600	600	600	1000	1000	1000	1000

PM1400 500	PM1400 600	PM1800 400	PM1800 500	PM1800 600	PM2000 400	PM2000 500	PM2000 600
1400	1400	1800	1800	1800	2000	2000	2000
500	600	400	500	600	400	500	600
40 / 60 / 90	40 / 60 / 90	40 / 60 / 90	40 / 60 / 90	40 / 60 / 90	40 / 60 / 90	40 / 60 / 90	40 / 60 / 90
300	600	600	600	1000	1000	1000	1000

PLANO PURE

HEIZKÖRPER

Plan Pure ist ein Heizkörper mit minimalistischem Design, das sich durch seine schlichte Form jeder Umgebung anpasst.

Als Zentralheizungs- und Elektrobetrieb erhältlich. Neben den Standard-Ausführungen auch in RAL-Farben.





Elektrobetrieb mit verdeckter Heizpatrone II mit handtuchhalter

MATERIAL Edelstahl / C-Stahl

OBERFLÄCHE



POLIERT



GEBÜRSTET



SCHWARZ
TEXTURIERT



WEISS



RAL FARBEN

ZUBEHÖR



ANSCHLUSS-
ARMATUR-SET



MIMOO
SWITCH



DOMOTIC
TOUCH



ELEKTROBETRIEB II

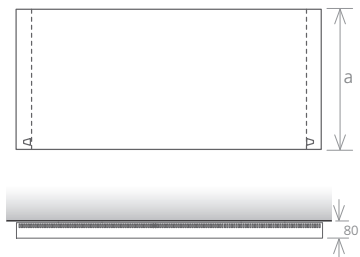

ELEKTROBETRIEB II

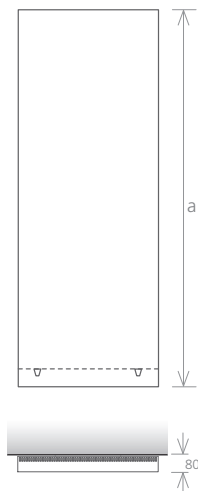



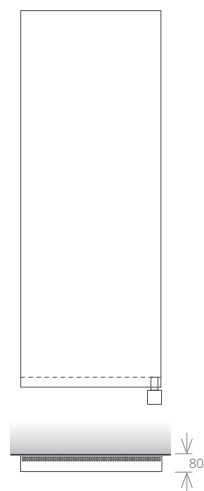

ELEKTROBETRIEB IV



* Unterschiedliche Abstände für Ventilposition in Kundenwahl.

** Tiefe < 80 mm möglich

HINWEIS: elektrische heizpatrone (heizstab) mit wärmeträgerflüssigkeit

					
		PP 650 1200	PP 650 1800	PP 650 2000	PP 1000 1000
Modell					
Höhe (mm)	a	650	650	650	1000
* Nabenabstand (mm)	b	-	-	-	-
Gesamtbreite (mm)	c	1200	1800	2000	1000
** Tiefe (mm)	d	80	80	80	80
Füllvolumen (l)		26,03	33,31	36,99	28,96
Gewicht (kg)		47,4	69,8	77,1	64,6
Zentralhzg.betr. (W)		2512	3768	4187	3382
El. Leistung II (W)		1200	1600	2000	1200
El. Leistung IV (W)		-	-	-	-

ZENTRALHEIZUNGSBETRIEB

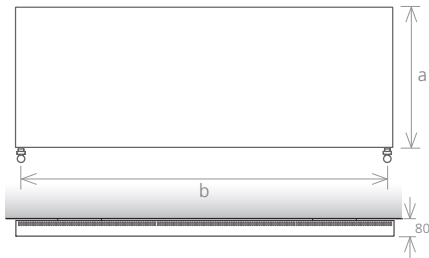

ZENTRALHEIZUNGSBETRIEB

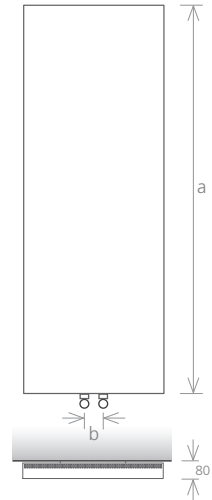

* Unterschiedliche Abstände für Ventilposition in Kundenwahl.

** Tiefe < 80 mm möglich

HINWEIS: elektrische heizpatrone (heizstab) mit wärmeträgerflüssigkeit

PP 1800 550	PP 2000 550	PP 1800 650	PP 2000 650	Modell
1800	2000	1800	2000	a (mm) Höhe
-	-	-	-	b (mm) Nabenabstand *
550	550	650	650	c (mm) Gesamtbreite
80	80	80	80	d (mm) Tiefe **
27,88	28,96	33,31	36,99	(l) Füllvolumen
59,1	75,2	69,8	77,1	(kg) Gewicht
3267	3630	3768	4187	(W) Zentralhgz.betr.
1600	2000	1600	2000	(W) El. Leistung II
1000	1000	1000	1000	(W) El. Leistung IV



PLANO PURE ON/OFF

HEIZKORPER



PLANO +

HEIZKÖRPER

Trotz der flachen Ausführung des Raumheizkörpers Plano+ ist eine hohe Wärmeleistung aufgrund seiner Form und Ausrichtungsmöglichkeit gewährleistet.





MATERIAL Edelstahl / C-Stahl

OBERFLÄCHE



POLIERT



GEBÜRSTET



SCHWARZ
TEXTURIERT







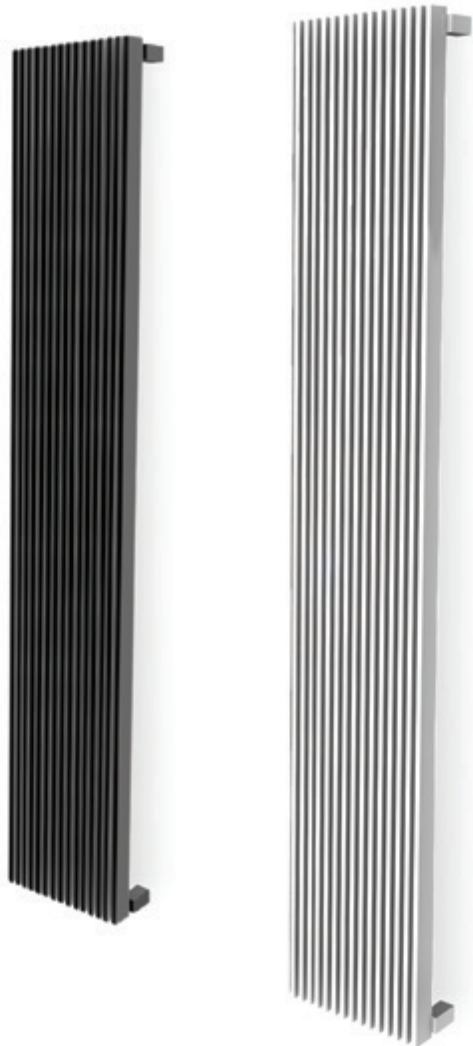

WEISS















RAL FARBEN















* Unterschiedliche Abstände für Ventilposition in Kundenwahl.









						
Modell	P+1200 10	P+1400 10	P+1800 10	P+2000 10	P+1200 25	P+1400 25
Anzahl der Heizelemente	10	10	10	10	25	25
Höhe (mm)	1200	1400	1800	2000	1200	1400
Gesamtbreite (mm)	210	210	210	210	510	510
Tiefe (mm)	120	120	120	120	120	120
Füllvolumen (l)	4,25	4,91	6,23	6,89	10,61	12,26
Gewicht (kg)	17,14	19,90	25,42	28,18	42,81	49,71
Zentralhzg.betr. (W)	782	901	1136	1256	1960	2259

						
Modell	P+1200 36	P+1400 36	P+1800 36	P+2000 36	P+1200 40	P+1400 40
Anzahl der Heizelemente	36	36	36	36	40	40
Höhe (mm)	1200	1400	1800	2000	1200	1400
Gesamtbreite (mm)	730	730	730	730	810	810
Tiefe (mm)	120	120	120	120	120	120
Füllvolumen (l)	15,28	17,65	22,38	24,75	16,97	19,60
Gewicht (kg)	61,64	71,57	91,45	101,38	68,48	79,52
Zentralhzg.betr. (W)	2826	3257	4099	4530	3139	3619

							
Modell	P+25 1200	P+25 1400	P+25 1800	P+31 1200	P+31 1400	P+31 1800	P+36 1200
Anzahl der Heizelemente	25	25	25	31	31	31	36
Höhe (mm)	510	510	510	630	630	630	730
Gesamtbreite (mm)	1200	1400	1800	1200	1400	1800	1200
Tiefe (mm)	120	120	120	120	120	120	120
Füllvolumen (l)	10,61	12,26	15,55	13,16	15,20	19,28	15,28
Gewicht (kg)	42,81	49,71	63,51	53,08	61,64	78,75	61,64
Zentralhzg.betr. (W)	1960	2259	2845	2432	2801	3157	2826

						Modell
P+1800 25	P+2000 25	P+1200 31	P+1400 31	P+1800 31	P+2000 31	Anzahl der Heizelemente
25	25	31	31	31	31	(mm) Höhe
1800	2000	1200	1400	1800	2000	(mm) Gesamtbreite
510	510	630	630	630	630	(mm) Tiefe
120	120	120	120	120	120	(l) Füllvolumen
15,55	17,19	13,16	15,20	19,28	21,32	(kg) Gewicht
63,51	70,41	53,08	61,64	78,75	87,31	(W) Zentralhgz.betr.
2845	3146	2432	2801	3157	3902	

						Modell
P+1800 40	P+2000 40	P+1200 60	P+1400 60	P+1800 60	P+2000 60	Anzahl der Heizelemente
40	40	60	60	60	60	(mm) Höhe
1800	2000	1200	1400	1800	2000	(mm) Gesamtbreite
810	810	1210	1210	1210	1210	(mm) Tiefe
120	120	120	120	120	120	(l) Füllvolumen
24,87	27,50	25,45	29,40	37,30	41,24	(kg) Gewicht
101,60	112,71	102,71	119,27	152,39	168,95	(W) Zentralhgz.betr.
4557	5030	4706	5427	6820	7520	

								Modell
P+36 1400	P+36 1800	P+40 1200	P+40 1400	P+40 1800	P+60 1200	P+60 1400	P+60 1800	Anzahl der Heiz.
36	36	40	40	40	60	60	60	(mm) Höhe
730	730	810	810	810	1210	1210	1210	(mm) Gesamtbreite
1400	1800	1200	1400	1800	1200	1400	1800	(mm) Tiefe
120	120	120	120	120	120	120	120	(l) Füllvolumen
17,65	22,38	16,97	19,60	24,87	25,45	29,40	37,30	(kg) Gewicht
71,57	91,45	68,48	79,52	101,60	102,71	119,27	152,39	(W) Zentralhgz.betr.
3257	4099	3139	3619	4557	4706	5427	6820	

PLANO

HEIZKÖRPER

Der Raumheizkörper Plano bereichert jedes Ambiente durch seine schlichten klaren Linien. Setzen Sie persönliche Akzente mit dem passenden Zubehör.



Heizpatrone II

PLANO

HEIZKORPER

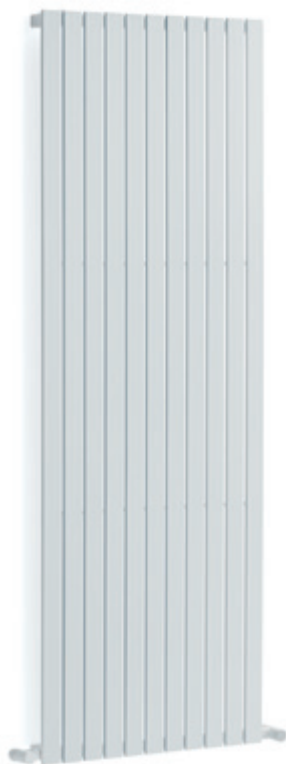

MATERIAL Edelstahl / C-Stahl

OBERFLÄCHE



POLIERT



GEBÜRSTET



SCHWARZ
TEXTURIERT



WEISS



RAL FARBEN

ZUBEHÖR



ANSCHLUSS-
ARMATUR-SET



MIMOO
SWITCH

















DOMOTIC
TOUCH



















Zentralheizungsbetrieb





* Unterschiedliche Abstände für Ventilposition in Kundenwahl.







								
Modell	P1200 4	P1400 4	P1800 4	P2000 4	P1200 8	P1400 8	P1800 8	P2000 8
Anzahl der Heizelemente	4	4	4	4	8	8	8	8
Höhe (mm)	1200	1400	1800	2000	1200	1400	1800	2000
Gesamtbreite (mm)	221	221	221	221	449	449	449	449
Tiefe (mm)	85	85	85	85	85	85	85	85
Füllvolumen (l)	2,01	2,29	2,98	3,25	4,10	4,70	5,98	6,32
Gewicht (kg)	7,24	8,34	10,55	11,65	14,49	16,70	21,12	23,32
Zentralhgz.betr. (W)	325	379	469	497	654	733	925	956
El. Leistung (W)	600	600	600	600	1000	1000	1000	1000

								
Modell	P1200 11	P1400 11	P1800 11	P2000 11	P1200 14	P1400 14	P1800 14	P2000 14
Anzahl der Heizelemente	11	11	11	11	14	14	14	14
Höhe (mm)	1200	1400	1800	2000	1200	1400	1800	2000
Gesamtbreite (mm)	620	620	620	620	791	791	791	791
Tiefe (mm)	85	85	85	85	85	85	85	85
Füllvolumen (l)	5,71	6,51	8,26	8,74	6,68	7,60	9,44	10,37
Gewicht (kg)	19,93	22,97	29,04	32,08	25,38	29,24	36,97	40,83
Zentralhgz.betr. (W)	864	997	1262	1388	1106	1276	1594	1603
El. Leistung (W)	1600	2000	2000	2000	2000	2000	2000	2000

								
Modell	P9 1200	P9 1400	P9 1800	P10 1200	P10 1400	P10 1800	P11 1200	P11 1400
Anzahl der Heizelemente	9	9	9	10	10	10	11	11
Höhe (mm)	506	506	506	563	563	563	620	620
Gesamtbreite (mm)	1200	1400	1800	1200	1400	1800	1200	1400
Tiefe (mm)	85	85	85	85	85	85	85	85
Füllvolumen (l)	4,54	5,30	6,69	5,11	5,97	7,44	5,71	6,51
Gewicht (kg)	16,31	18,79	23,76	18,12	20,88	26,40	19,93	22,97
Zentralhgz.betr. (W)	713	829	1002	814	933	1142	864	997
El. Leistung (W)	1200	1200	1200	1200	1200	1200	1200	1600

								Modell
P1200 9	P1400 9	P1800 9	P2000 9	P1200 10	P1400 10	P1800 10	P2000 10	Anzahl der Heizelemente
9	9	9	9	10	10	10	10	(mm) Höhe
1200	1400	1800	2000	1200	1400	1800	2000	(mm) Gesamtbreite
506	506	506	506	563	563	563	563	(mm) Tiefe
85	85	85	85	85	85	85	85	(l) Füllvolumen
4,54	5,30	6,69	7,21	5,11	5,97	7,44	8,10	(kg) Gewicht
16,31	18,79	23,76	26,24	18,12	20,88	26,40	29,16	(W) Zentralhgz.betr.
713	829	1022	1117	814	933	1142	1263	(W) El. Leistung
1200	1600	2000	2000	1200	1200	2000	2000	

				Modell
P1200 21	P1400 21	P1800 21	P2000 21	Anzahl der Heizelemente
21	21	21	21	(mm) Höhe
1200	1400	1800	2000	(mm) Gesamtbreite
1190	1190	1190	1190	(mm) Tiefe
85	85	85	85	(l) Füllvolumen
10,03	11,41	14,17	15,55	(kg) Gewicht
38,07	43,87	55,46	62,55	(W) Zentralhgz.betr.
1649	1899	2390	2641	(W) El. Leistung
2000	2000	2000	2000	

							Modell
P11 1800	P14 1200	P14 1400	P14 1800	P21 1200	P21 1400	P21 1800	Anzahl der Heizelemente
11	14	14	14	21	21	21	(mm) Höhe
620	791	791	791	1190	1190	1190	(mm) Gesamtbreite
1800	1200	1400	1800	1200	1400	1800	(mm) Tiefe
85	85	85	85	85	85	85	(l) Füllvolumen
8,26	6,68	7,60	9,44	10,03	11,41	14,17	(kg) Gewicht
29,04	25,38	29,24	36,97	38,07	43,87	55,46	(W) Zentralhgz.betr.
1262	1106	1276	1594	1649	1899	2390	(W) El. Leistung
2000	1600	1600	2000	1600	2000	2000	

ZUBEHÖR

DOMOTIC TOUCH	240
MIMOO SWITCH	244
ELEKTRISCHE HEIZPATRONE	246
HEIZKÖRPERVENTILE	248
SONSTIGES ZUBEHÖR	256

DOMOTIC TOUCH

TECHNOLOGY

Domotic Touch ist ein einfaches Steuerungselement mit den Installationsparametern handelsüblicher Schalter.

Spar-Funktion

Erhöht die Energieeffizienz durch die Einstellung der gewünschten Heizdauer (ein, zwei oder drei Stunden).

Komfort-Funktion

Einstellung der gewünschten Komforttemperatur des Raumes und Steuerung des Energieverbrauchs durch die Temperatureinstellung (18° C, 20° C, 22° C, 24° C). Ausgestattet mit einem Raumtemperatursensor.

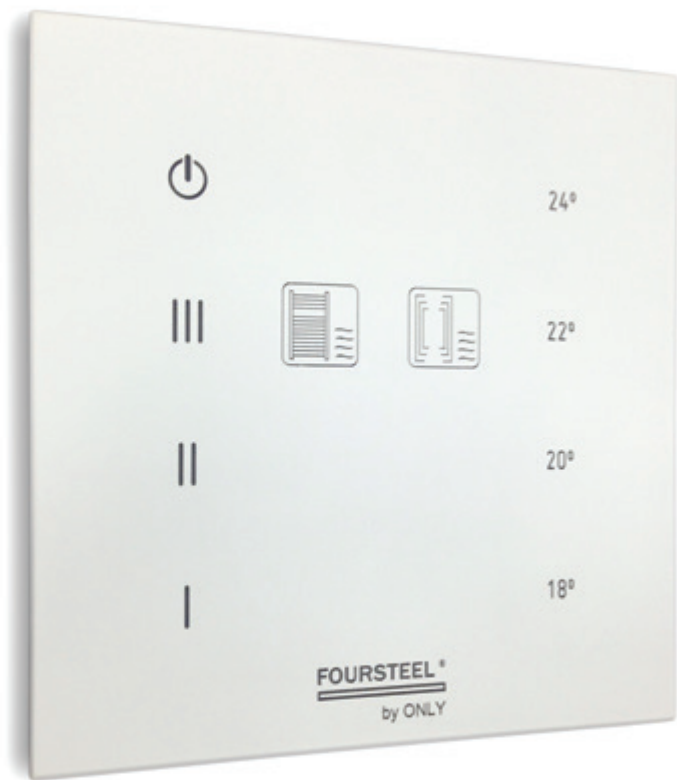

90mm x 90mm x 5mm
IP44

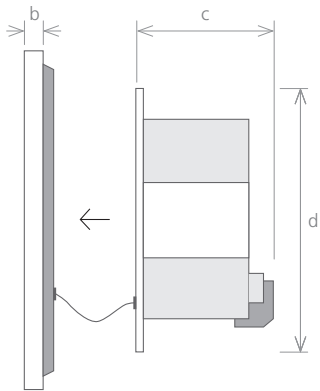

element 1 element 2

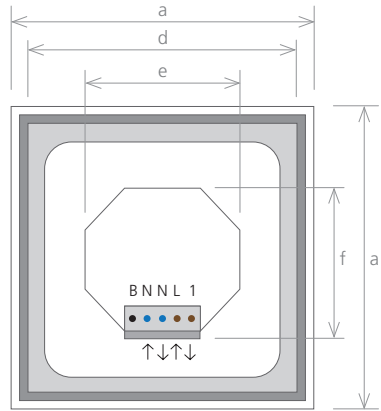

- B -
- N Eingang Neutral
- N Ausgang Neutral des Heizkörpers
- L Eingang Phase
- 1 Ausgang Phase des Heizkörpers

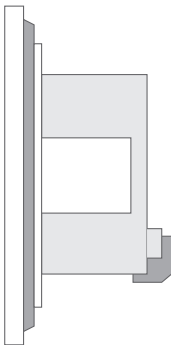

element 1 + 2

Modell	DT
Gesamtaußenmaße (mm)	a 90 x 90
Außentiefe (mm)	b 5
Tiefe des inneren Teils (mm)	c 40
Gesamtinnenmaße (mm)	d 73 x 73
Horizontales Maß des hinteren Teils (mm)	e 55
Vertikales Maß des hinteren Teils (mm)	f 51

DOMOTIC TOUCH

TECHNOLOGY

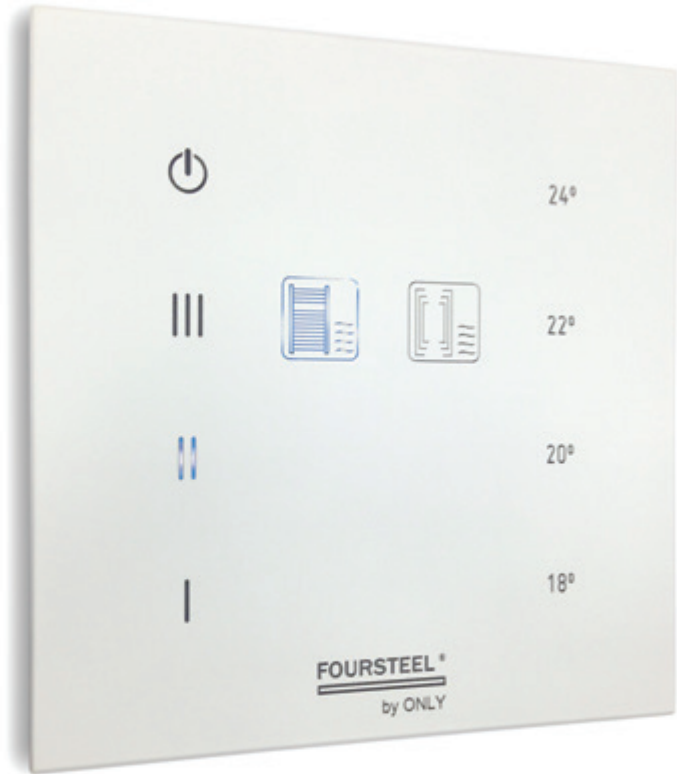

MIMOO SWITCH

Foursteel präsentiert ein neues Gerät zur Steuerung der Handtuchwärmer oder Heizkörper. Völlig Edelstahl. Funktionalität, Komfort und Eleganz, das minimalistische Konzept passt mit allen Elektrobetrieb Ware von Foursteel.





GEBÜRSTET GOLD



POLIERT GOLD



GEBÜRSTET KUPFER



POLIERT KUPFER



GEBÜRSTET



POLIERT



SCHWARZ TEXTURIERT



WEISS

ELEKTRISCHE HEIZPATRONEN

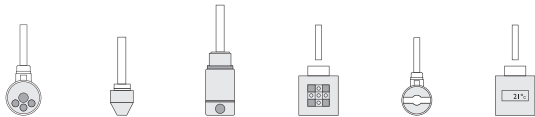

Schutzklasse	1	2	1	2	2	2
IP-Schutzart	IP X4	IP64 / IP67*	IP 64	IP X5	IP X4	IP X4
vertikale Ausrichtungsmöglichkeit	●	●	●	●	●	●
horizontale Ausrichtungsmöglichkeit		●		●		
Einschaltknopf	●		●	●	●	●
Temperurregler	●		●	●	●	●
zweistündiger Timer				●	●	●
Raumtemperatur-Sensor				●		●
programmierbar						●

* Nur für Heizpatrone mit 40W

ELEMENT I

nur in Portugal erhältlich



VERCHROMT GEBÜRSTET WEISS

ELEMENT II



standard

ELEMENT III

nur in Portugal erhältlich



VERCHROMT GEBÜRSTET WEISS

ELEMENT IV



VERCHROMT GEBÜRSTET

ELEMENT V



VERCHROMT

ELEMENT VI



VERCHROMT

HEIZKÖRPERVENTILE

ZUBEHÖR

HEIZKÖRPERVENTIL-SET 1

Eckventil und Eckrücklaufverschraubung (manuell + quadratisch)

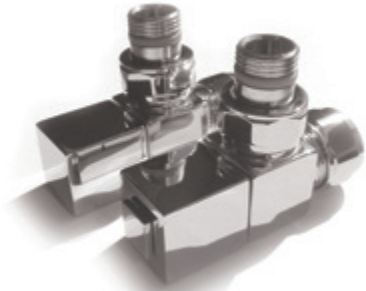

VERCHROMT



GEBÜRSTET



WEISS



SCHWARZ

HEIZKÖRPERVENTIL-SET 2

Eckventil und Eckrücklaufverschraubung (manuell + quadratisch)



VERCHROMT



GEBÜRSTET



HEIZKÖRPERVERTIL-SET 3

Eckventil und Eckrücklaufverschraubung (manuell + rund)



VERCHROMT



GEBÜRSTET

HEIZKÖRPERVERTIL-SET 4

Eckventil und Eckrücklaufverschraubung (manuell + rund)



VERCHROMT



GEBÜRSTET



WEISS

SCHWARZ



WEISS

SCHWARZ

HEIZKÖRPERVENTIL-SET 5

manuelle Ventile 5500 Kreuzkopf



VERCHROMT



GEBÜRSTET

manuelle Ventile 5900 french style



VERCHROMT



GEBÜRSTET

HEIZKÖRPERVENTIL-SET 6

manuelle Ventile



VERCHROMT



GEBÜRSTET

manuelle Ventile



WEISS

manuelle Ventile 5400 english style



VERCHROMT



GEBÜRSTET

* Bitte bestellen Sie immer zwei Ventile pro Heizkörper.

HEIZKÖRPERVENTIL-SET 7

Winkel-Eckventil und Rücklaufverschraubung



VERCHROMT



GEBÜRSTET



VERCHROMT



GEBÜRSTET

THERMOSTATVENTIL-SET 1

Ventil und Rücklaufverschraubung



VERCHROMT



GEBÜRSTET



WEISS

THERMOSTATVENTIL-SET 2

Ventil mit Thermostatkopf

Eck-Rücklaufverschraubung



VERCHROMT



GEBÜRSTET



VERCHROMT



GEBÜRSTET

Thermostatkopf



VERCHROMT

GEBÜRSTET

WEISS



VERCHROMT

GEBÜRSTET

WEISS

ANSCHLUSSARMATUR-SET

Thermostatventil



VERCHROMT

GEBÜRSTET

SONSTIGES ZUBEHÖR

T-STÜCK FÜR MISCHBETRIEB 1
Anschlüsse 1/2"



VERCHROMT



GEBÜRSTET



WEISS

T-STÜCK FÜR MISCHBETRIEB 2
Anschlüsse 1/2"



VERCHROMT



GEBÜRSTET



WEISS

WANDHALTERUNG

Wandhalterung I für Heizkörper



VERCHROMT



GEBÜRSTET

Wandhalterung II für Heizkörper



VERCHROMT



GEBÜRSTET

Entlüftungsstopfen 1/2"

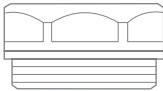

VERCHROMT

Entlüftungsstopfen 1/8"

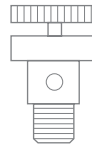

VERCHROMT

HINWEIS : Alle unsere elektrischen Heizkörper bestehen aus elektrischer Heizpatrone (Heizstab) und Wärmeträgerflüssigkeit

FOURSTEEL®

[heating products factory]

Foursteel - Produtos em Inox, Lda
Centro Empresarial de Aveiro
Zona Industrial de Mamodeiro
3811-783 Aveiro
PORTUGAL
T +351 234 111 967
F +351 234 940 414
commercial.dep@foursteel.eu
www.foursteel.eu



FOURSTEEL®
[heating products factory]

www.foursteel.eu