

FOURSTEEL®

[heating products factory]

HEATING PRODUCTS DESIGNED
AND DEVELOPED BY FOURSTEEL®

24

ENGLISH VERSION

FOURSTEEL®

CORPORATE

Foursteel is a Portuguese producer of design heating radiators and towel warmers.

Focused on market needs, in collaboration with architects and designers creates distinctive radiators in stainless steel and steel, developing efficient heating solutions with contemporary and minimalist concepts.

FOURSTEEL® INDEX



10
MINIMAL



14
MINIMAL X

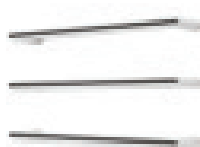

16
M TUBE



18
M TUBE SQUARE



20
M TUBE ROUND



22
M SLIM



24
M SLIM SQUARE



26
FOURSLIM BY ARCH.



30
FOURSLIM ON OFF



32
FOURSLIM SQUARE



36
FOURSLIM SQUARE
ON OFF



38
FOURSLIM SQUARE
LED



40

SKINNY



44

STEEL GLAM



48

STEEL ELEGANCE

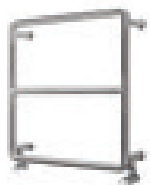

50

FOURFOZ



52

FOURFOZ ON OFF



54

STEEL WAVE

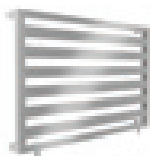

56

STEEL STONE



58

STEEL CLASSIC



60

STEEL GLAMOUR



62

STEEL STYLE

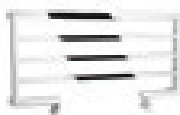

64

NEW SLIM



66

BASIC LINE



70
NEW BASIC



74
EMPRESS

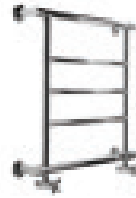

76
OLD BEAUTY

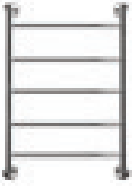

78
REMIND



80
FLOOR REMIND

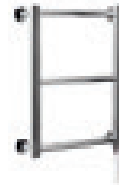

82
RETRO SPECIAL

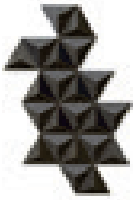

84
DIAMOND



86
DIAMOND XS



87
ARENA TABLE



88
ARENA



90
CURVE



92
D LIGNE



94
DIVINE



96
LINEAR

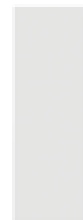

98
PLANO MOVE

FOURSTEEL® INDEX



100
PLANO PURE



102
PLANO PURE ON OFF



104
PLANO +

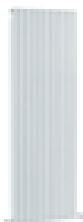

108
PLANO



110
DOMOTIC TOUCH



112
SWITCH ON OFF



114
MIMOO SWITCH



115
MIMOO SWITCH
ROUND



117
ELECTRIC ELEMENTS



118
VALVES



122
OTHER ACCESSORIES

FOURSTEEL®

Foursteel, Lda
Centro Empresarial de Aveiro
Zona Industrial de Mamodeiro
3810-783 Aveiro
PORTUGAL

T +351 234 111 967

T +351 234 107 263

www.foursteel.eu

geral@foursteel.eu

+351 935 212 579

IMPORTANT NOTES:

1. When the position of the electric element is not identified It will always be placed in the lower right side;
2. All our electric heaters consist of electric heater cartridge (heater bar) and thermal fluid.
3. Foursteel® reserves the right to change all the products and related drawings featured in this catalogue without any prior notice.
4. All Foursteel® products are adaptable in terms of size and capacity.

RAL COLORS: color subject to confirmation.

WHITE: RAL 9016 (Standard version)

Certification of electrical products, according to the standards:

IECEN 60335-2-43:

IEC 60335-1:2010 + COR1: 2010 + COR2:2011 + A1:2013 EN 60335-1:2012 + AC:2014 + A11:2014

IEC 60335-2-43:2002 + A1:2005 + A2:2008 EN 60335-2-43:2003 + A1:2006 + A2:2008

Certification of central heating products, according to the standard UN:

EN442 - 2

UL Certification:

UL 499 - Electric Heating Appliances

E506585



MINIMAL





TOWEL WARMER

ARCHITECT: MANUEL AIRES MATEUS

Palácio Condes de Murça in Lisbon.



FINISHINGS

-  Polished
-  Brushed
-  Textured Black
-  White 9016 Satin
-  RAL Colour

PVD FINISHING

-  Champagne
-  Gold
-  Copper
-  Gun Metal

ACCESSORIES

-  Domotic Touch
-  Mimoo Switch
-  Mimoo Switch Round

VERSION

-  Electric

MATERIAL

-  Stainless Steel

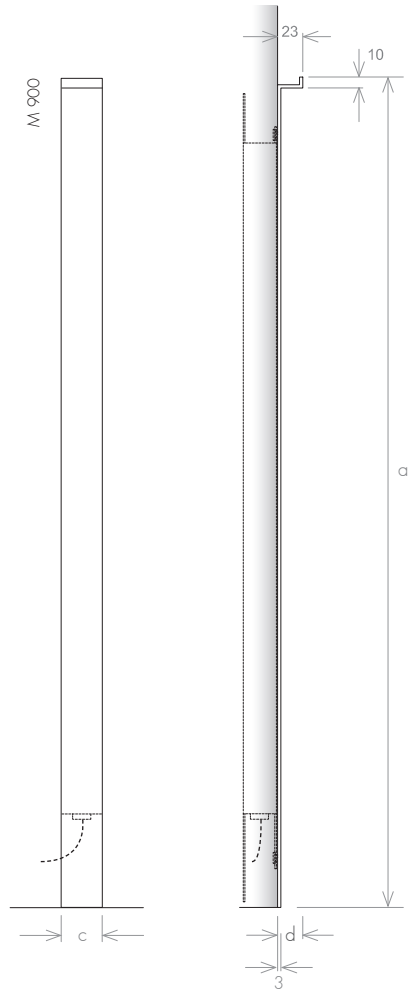

model		M 900	M 1200	M 1400	M 1800
height (mm)	a	900	1200	1400	1800
total width (mm)	c	35	35	35	35
depth (mm)	d	23	23	23	23
capacity (l)		0,6	0,8	1,0	1,3
electric (W)		100	150	150	200

TOP VIEW

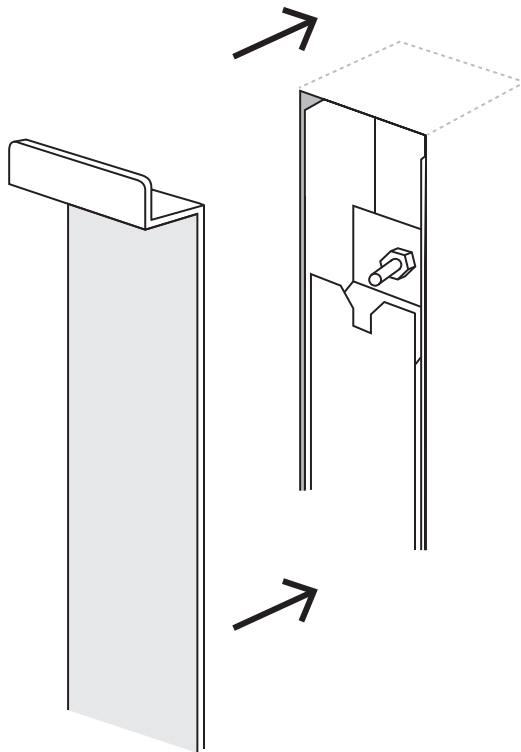
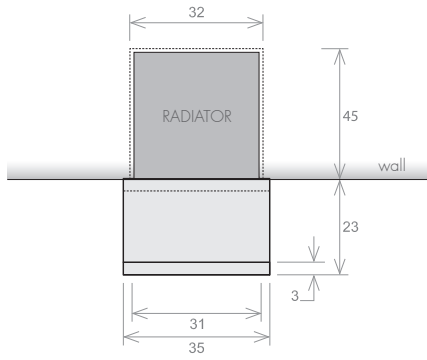



MINIMAL X

TOWEL WARMER





FRONT VIEW

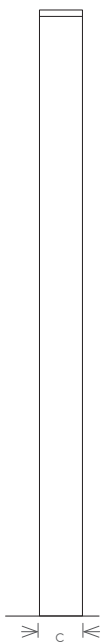

SIDE VIEW

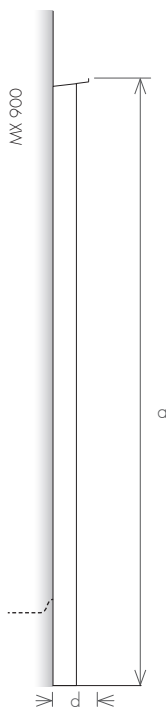

SIDE VIEW

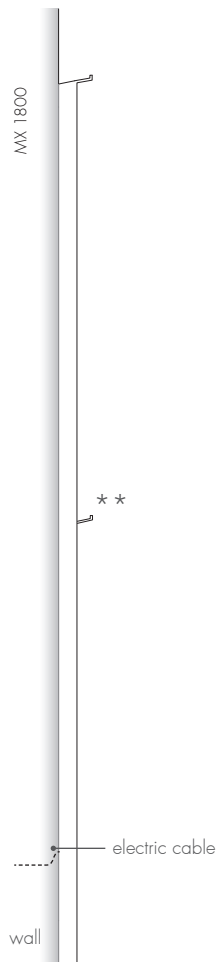

** the second support is only implemented in the model MX1800





model		MX 900	MX 1200	MX 1400	MX 1800
height (mm)	a	900	1200	1400	1800
total width (mm)	c	50	50	50	50
depth (mm)	d	50	50	50	50
capacity (l)		0,6	0,8	1,0	1,3
electric (W)		100	150	150	200

M TUBE

TOWEL WARMER





FINISHINGS

-  Polished
-  Brushed
-  Textured Black
-  White 9016 Satin
-  RAL Colour

PVD FINISHING

-  Champagne
-  Gold
-  Copper
-  Gun Metal

ACCESSORIES

-  Domotic Touch
-  Mimoo Switch
-  Mimoo Switch Round

VERSION

-  Electric

MATERIAL

-  Stainless Steel

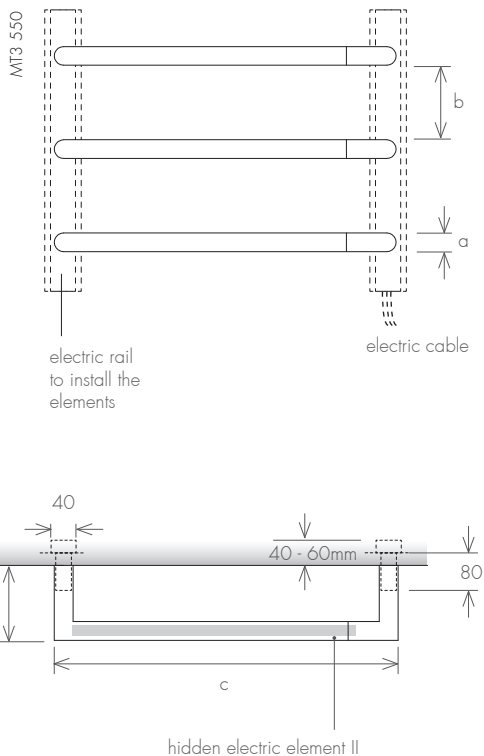



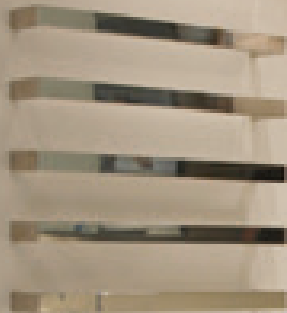

model	MT3 550	additional elem.	MT3 800	additional elem.
no. of elements	3	1	3	1
height (mm) a	30	30	30	30
width between elements (mm) b	120	-	120	-
total width (mm) c	550	550	800	800
depth (mm) d	120	120	120	120
capacity (l)	3x0,4	0,4	3x0,6	0,6
electric (W)	3x40	40	3x40	40

M TUBE SQUARE

TOWEL WARMER





FINISHINGS

-  Polished
-  Brushed
-  Textured Black
-  White 9016 Satin
-  RAL Colour

PVD FINISHING

-  Champagne
-  Gold
-  Copper
-  Gun Metal

ACCESSORIES

-  Domotic Touch
-  Mimoo Switch
-  Mimoo Switch Round

VERSION

-  Electric

MATERIAL

-  Stainless Steel

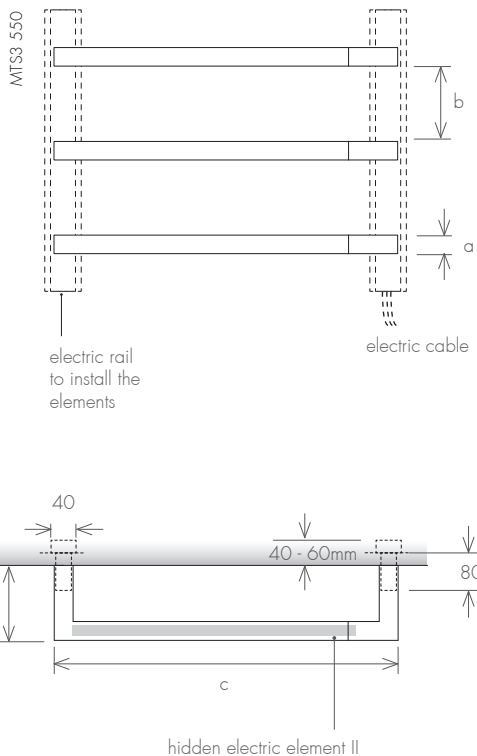





model	no. of elements	MTS3 550 additional elem.		MTS3 800 additional elem.	
		3	1	3	1
height (mm)	a	30	30	30	30
width between elements (mm)	b	120	-	120	-
total width (mm)	c	550	550	800	800
depth (mm)	d	120	120	120	120
capacity (l)		3x0,4	0,4	3x0,6	0,6
electric (W)		3x40	40	3x40	40

M TUBE ROUND

TOWEL WARMER



FINISHINGS

-  Polished
-  Brushed
-  Textured Black
-  White 9016 Satin
-  RAL Colour

PVD FINISHING

-  Champagne
-  Gold
-  Copper
-  Gun Metal

ACCESSORIES

-  Domotic Touch
-  Mimoo Switch
-  Mimoo Switch Round

VERSION

-  Electric

MATERIAL

-  Stainless Steel

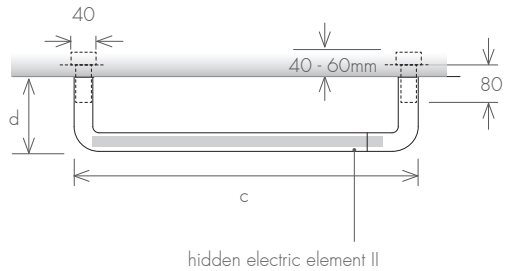
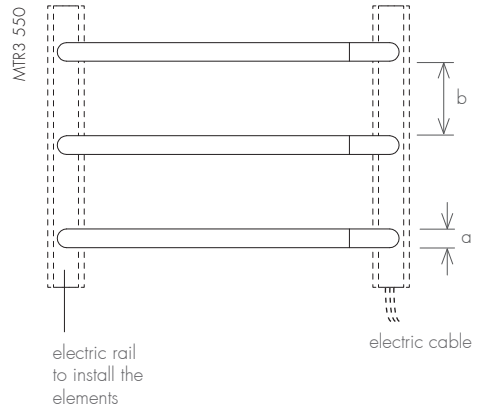

model	MTR3 550 additional elem.		MTR3 800 additional elem.	
no. of elements	3	1	3	1
height (mm) a	30	30	30	30
width between elements (mm) b	120	-	120	-
total width (mm) c	550	550	800	800
depth (mm) d	120	120	120	120
capacity (l)	3x0,4	0,4	3x0,6	0,6
electric (W)	3x40	40	3x40	40





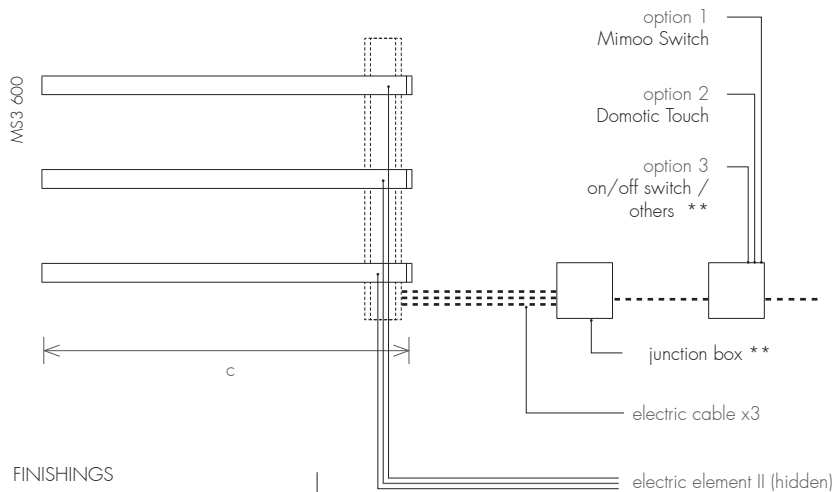

M SLIM

TOWEL WARMER





FINISHINGS

-  Polished
-  Brushed
-  Textured Black
-  White 9016 Satin
-  RAL Colour

PVD FINISHING

-  Champagne
-  Gold
-  Copper
-  Gun Metal

ACCESSORIES

-  Domotic Touch
-  Mimoo Switch
-  Mimoo Switch Round

VERSION

-  Electric

MATERIAL

-  Stainless Steel

** Products not provided by Foursteel.

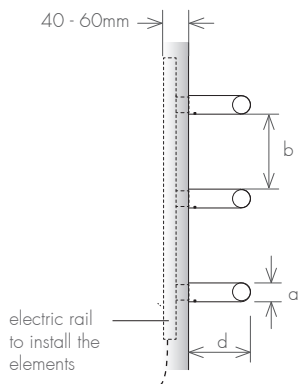

model	MS3 600	additional elem.
no. of elements	3	1
height (mm) a	30	30
width between elements (mm) b	120	-
total width (mm) c	600	600
depth (mm) d	80	80
capacity (l)	3x0,6	0,6
electric (W)	3x40	40





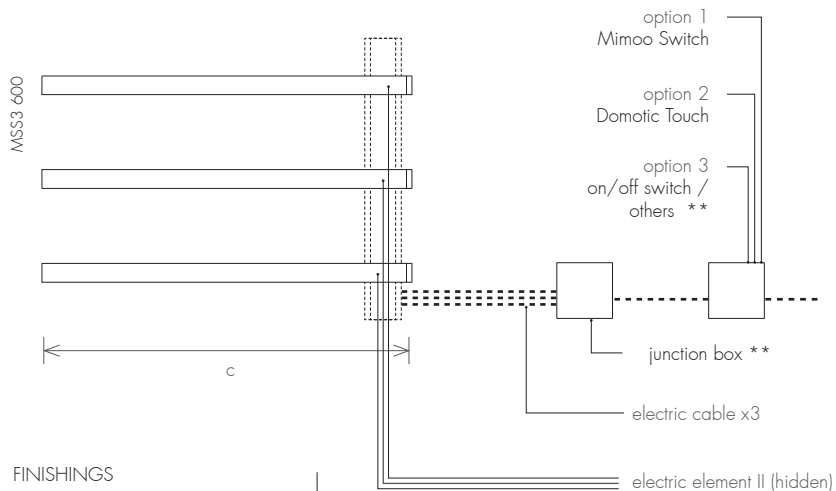

M SLIM SQUARE

TOWEL WARMER





FINISHINGS

-  Polished
-  Brushed
-  Textured Black
-  White 9016 Satin
-  RAL Colour

PVD FINISHING

-  Champagne
-  Gold
-  Copper
-  Gun Metal

ACCESSORIES

-  Domotic Touch
-  Mimoo Switch
-  Mimoo Switch Round

VERSION

-  Electric

MATERIAL

-  Stainless Steel



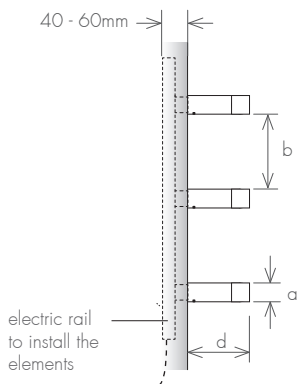

** Products not provided by Foursteel.



model	MSS3 600	additional elem.
no. of elements	3	1
height (mm) a	30	30
width between elements (mm) b	120	-
total width (mm) c	600	600
depth (mm) d	80	80
capacity (l)	3x0,6	0,6
electric (W)	3x40	40







FINISHINGS

-  Polished
-  Brushed
-  Textured Black
-  White 9016 Satin
-  RAL Colour



PVD FINISHING

-  Champagne
-  Gold
-  Copper
-  Gun Metal

ACCESSORIES

-  Domotic Touch
-  Mimoo Switch
-  Mimoo Switch Round
-  Wall Valve

VERSION

-  Central Heating
-  Electric
-  Mixed

MATERIAL

-  Stainless Steel

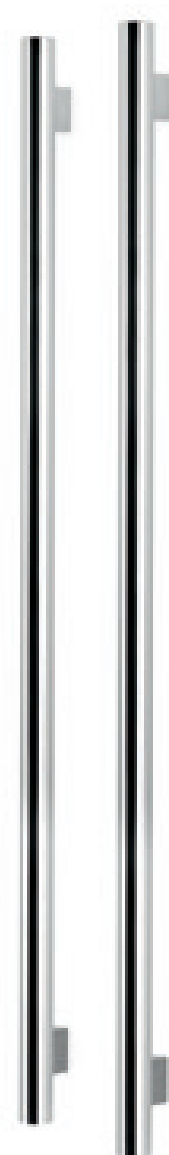

sold individually

FOURSLIM BY ARCH.

TOWEL WARMER

CENTRAL HEATING - solution 1

The connection of water inlet is done by a system of wall valves outside of the product.

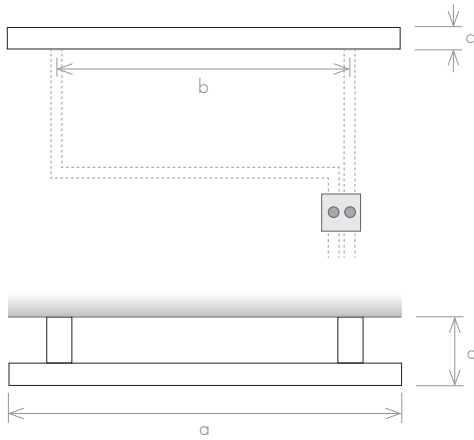

CENTRAL HEATING - solution 2

Hidden valves

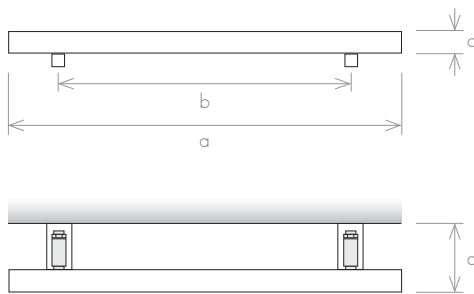

central heating - wall valve system

central heating - valves

FSA 800	FSA 1200	FSA 1400	FSA 800	FSA 1200	FSA 1400	model
800	1200	1400	800	1200	1400	a (mm) height
620	1020	1220	620	1020	1220	b (mm) width between axles
42	42	42	42	42	42	c (mm) total width
100	100	100	130	130	130	d (mm) depth
0,7	0,9	1,2	0,7	0,9	1,2	(l) capacity
63	97	124	63	97	124	(W) central heating

VERSION: HIDDEN ELECTRIC ELEMENT II

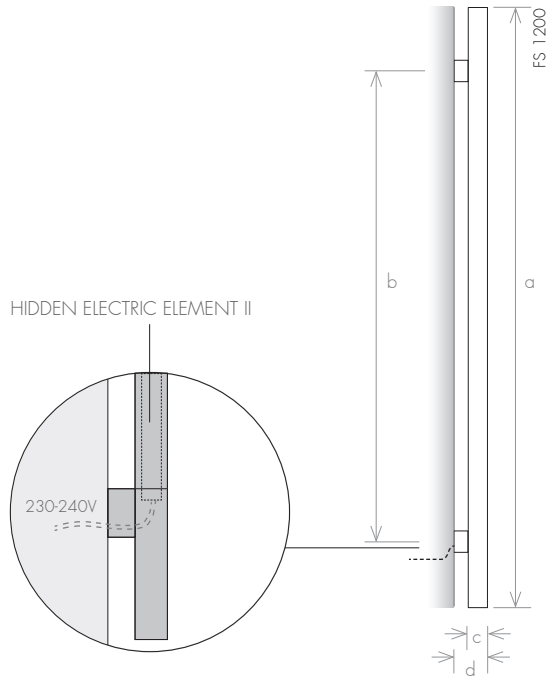

Electric version: in the horizontal position the depth is 75mm.





		hidden electric element II			mixed version - wall valve + electric II		
model		FS 800	FS 1200	FS 1400	FSM 800	FSM 1200	FSM 1400
height (mm)	a	800	1200	1400	880	1280	1480
width between axles (mm)	b	-	-	-	620	1020	1220
total width (mm)	c	35	35	35	42	42	42
depth (mm)	d	65	65	65	100	100	100
capacity (l)		0,6	0,8	1,0	0,7	0,9	1,2
central heating (V)		-	-	-	63	97	124
electric (V)		40	100	100	40	100	100



FOURSLIM ON/OFF

TOWEL WARMER





FINISHINGS

-  Polished
-  Brushed
-  Textured Black
-  White 9016 Satin
-  RAL Colour



PVD FINISHING

-  Champagne
-  Gold
-  Copper
-  Gun Metal

ACCESSORIES

-  Domotic Touch
-  Mimoo Switch
-  Mimoo Switch Round
-  Wall Valve

VERSION

-  Central Heating
-  Electric
-  Mixed

MATERIAL

-  Stainless Steel

BOTTOM VIEW

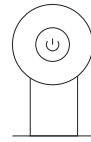

HIDDEN ELECTRIC ELEMENT II

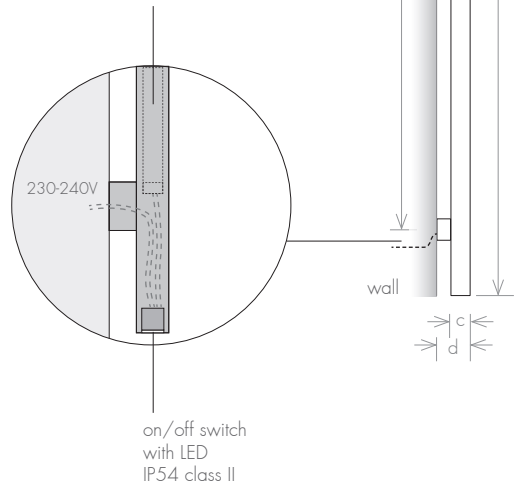

Electric version: in the horizontal position the depth is 82mm.





		hidden electric element II - on/off			mixed version - wall valve + on/off		
model		FSO 800	FSO 1200	FSO 1400	FSOM 800	FSOM 1200	FSOM 1400
height (mm)	a	800	1200	1400	800	1200	1400
width between axles (mm)	b	-	-	-	520	920	1120
total width (mm)	c	42	42	42	42	42	42
depth (mm)	d	72	72	72	100	100	100
capacity (l)		0,6	0,8	1,0	0,7	0,9	1,2
central heating (W)		-	-	-	63	97	124
electric (W)		100	100	150	40	100	100



FOURSLIM SQUARE

TOWEL WARMER





FINISHINGS

-  Polished
-  Brushed
-  Textured Black
-  White 9016 Satin
-  RAL Colour



PVD FINISHING

-  Champagne
-  Gold
-  Copper
-  Gun Metal

ACCESSORIES

-  Domotic Touch
-  Mimoo Switch
-  Mimoo Switch Round
-  Wall Valve

VERSION

-  Central Heating
-  Electric
-  Mixed

MATERIAL

-  Stainless Steel

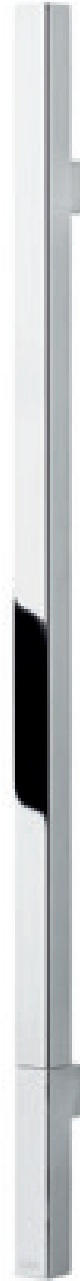

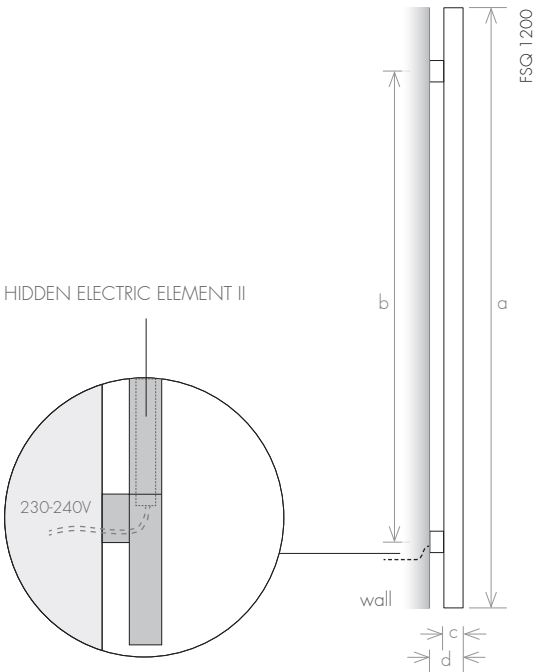

Electric version: in the horizontal position the depth is 80mm.

hidden electric element II			mixed version - wall valve + electric			
FSQ 800	FSQ 1200	FSQ 1400	FSQM 800	FSQM 1200	FSQM 1400	model
800	1200	1400	880	1280	1480	a (mm) height
-	-	-	620	1020	1220	b (mm) width between axles
40	40	40	40	40	40	c (mm) total width
70	70	70	98	98	98	d (mm) depth
0,6	0,8	1,0	0,7	0,9	1,2	(l) capacity
-	-	-	63	97	124	(W) central heating
100	100	150	40	100	100	(W) electric

CENTRAL HEATING - solution 1

The connection of water inlet is done by a system of wall valves outside of the product.



CENTRAL HEATING - solution 2

Hidden valves

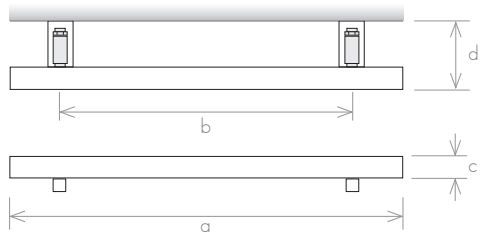





		central heating - wall valve system			central heating - valves		
model		FSQA 800	FSQA 1200	FSQA 1400	FSQA 800	FSQA 1200	FSQA 1400
height (mm)	a	800	1200	1400	800	1200	1400
width between axles (mm)	b	620	1020	1220	620	1020	1220
total width (mm)	c	40	40	40	40	40	40
depth (mm)	d	98	98	98	128	128	128
capacity (l)		0,7	0,9	1,2	0,7	0,9	1,2
central heating (W)		63	97	124	63	97	124

**FOURSLIM
SQUARE
ON/OFF**

TOWEL WARMER







FINISHINGS

-  Polished
-  Brushed
-  Textured Black
-  White 9016 Satin
-  RAL Colour

PVD FINISHING

-  Champagne
-  Gold
-  Copper
-  Gun Metal

ACCESSORIES

-  Domotic Touch
-  Mimoo Switch
-  Mimoo Switch Round
-  Wall Valve

VERSION

-  Electric
-  Mixed

MATERIAL

-  Stainless Steel

VERSION: HIDDEN ELECTRIC ELEMENT II

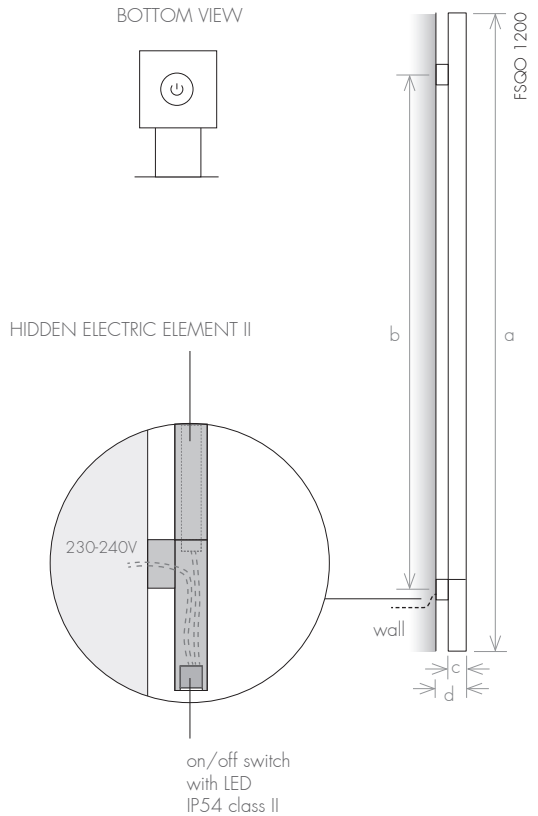

Electric version: in the horizontal position the depth is 80mm.



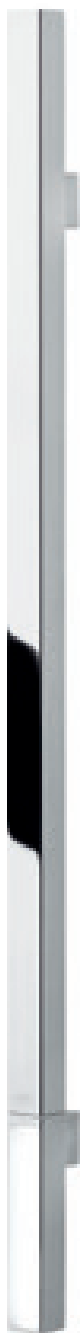

		hidden electric element II			mixed version - wall valve + electric II		
	model	FSGO800	FSGO1200	FSGO1400	FSGQM800	FSGQM1200	FSGQM1400
height (mm)	a	800	1200	1400	800	1200	1400
width between axles (mm)	b	-	-	-	520	920	1120
total width (mm)	c	40	40	40	40	40	40
depth (mm)	d	70	70	70	98	98	98
capacity (l)		0,6	0,8	1,0	0,7	0,9	1,2
central heating (W)		-	-	-	63	97	124
electric (W)		100	100	150	100	100	150

**FOURSLIM
SQUARE
LED**

TOWEL WARMER





FINISHINGS

-  Polished
-  Brushed
-  Textured Black
-  White 9016 Satin
-  RAL Colour

PVD FINISHING

-  Champagne
-  Gold
-  Copper
-  Gun Metal

ACCESSORIES

-  Domotic Touch
-  Mimoo Switch
-  Mimoo Switch Round

VERSION

-  Electric

MATERIAL

-  Stainless Steel

VERSION: HIDDEN ELECTRIC ELEMENT II

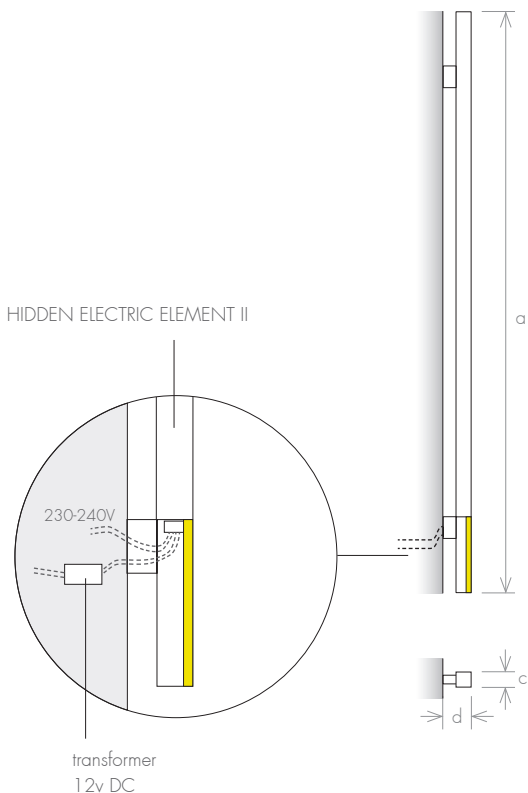





model		FSQL 800	FSQL 1200	FSQL 1400
height (mm)	a	800	1200	1400
width between axles (mm)	b	-	-	-
total width (mm)	c	40	40	40
depth (mm)	d	70	70	70
capacity (l)		0,6	0,8	1,0
electric (W)		100	100	150



SKINNY
TOWEL WARMER



FINISHINGS

-  Polished
-  Brushed
-  Textured Black
-  White 9016 Satin
-  RAL Colour

PVD FINISHING

-  Champagne
-  Gold
-  Copper
-  Gun Metal

ACCESSORIES

-  Domotic Touch
-  Mimoo Switch
-  Mimoo Switch Round

VERSION

-  Electric

MATERIAL

-  Stainless Steel

VERSION: FLOOR MOUNTED

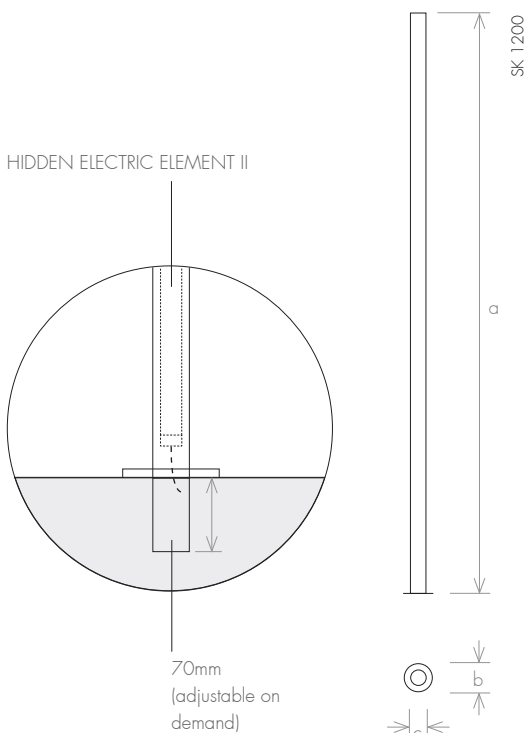

		floor mounted		
model		SK 900	SK 1200	SK 1400
height (mm)	a	900	1200	1400
total width (mm)	b	90	90	90
tube diameter (mm)	c	42	42	42
capacity (l)		0,6	0,8	1,0
electric (W)		100	100	150



VERSION: MOBILE

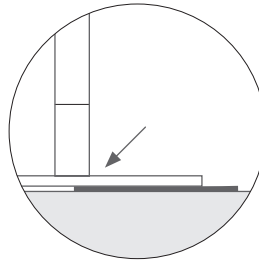
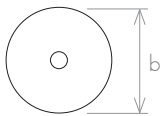
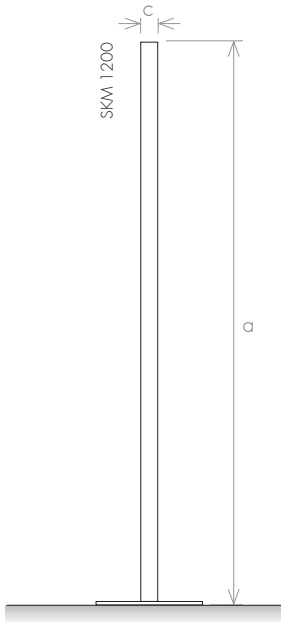

OPTION A
electric cable exit through
the bottom

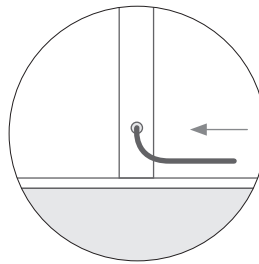

OPTION B
lateral exit of the
electric cable

NOTE: Also available in the square version.





		mobile		
model		SKM 900	SKM 1200	SKM 1400
height (mm)	a	900	1200	1400
total width (mm)	b	280	280	280
tube diameter (mm)	c	42	42	42
capacity (l)		0,6	0,8	1,0
electric (W)		100	100	150



STEEL GLAM

TOWEL WARMER

FINISHINGS





-  Polished
-  Brushed
-  Textured Black
-  White 9016 Satin
-  RAL Colour

PVD FINISHING



maximum dimensions of 1000mm

-  Champagne
-  Gold
-  Copper
-  Gun Metal

ACCESSORIES

-  Domotic Touch
-  Mimoo Switch
-  Mimoo Switch Round
-  Wall Valve

VERSION

-  Central Heating
-  Electric

MATERIAL

-  Stainless Steel



STEEL GLAM normal
(SG)



STEEL GLAM sharp corner
(SGS)

model		SG 800E	SG 800L	SG 1200E	SG 1200L	SG 1800E	SG 1800L
height	(mm) a	800	800	1200	1200	1800	1800
width between axles	(mm) b	450	500	450	500	450	500
total width	(mm) c	480	530	480	530	480	530
depth	(mm) d	90	90	90	90	90	90
capacity	(l)	2,8	3,1	4,0	4,6	6,6	7,1
central heating	(W)	250	296	360	438	613	657
electric	(W)	300	300	600	600	1000	1000



VERSION: CENTRAL HEATING

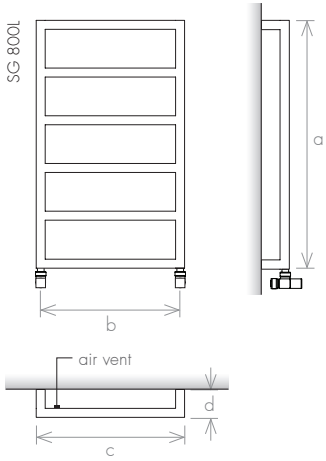

VERSION: ELECTRIC IV

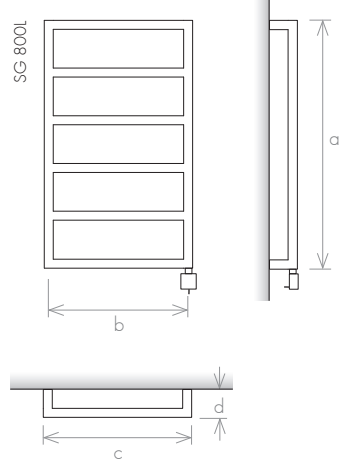

VERSION: HIDDEN ELECTRIC ELEMENT II

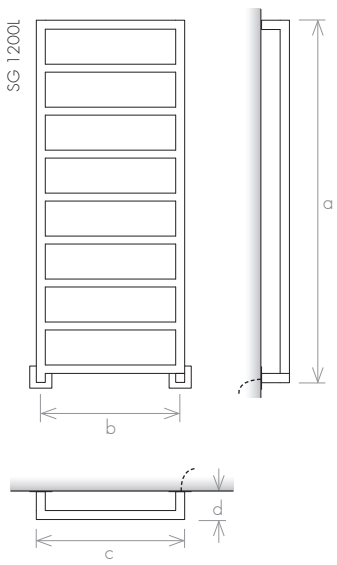

VERSION: MIXED WITH ELEMENT IV

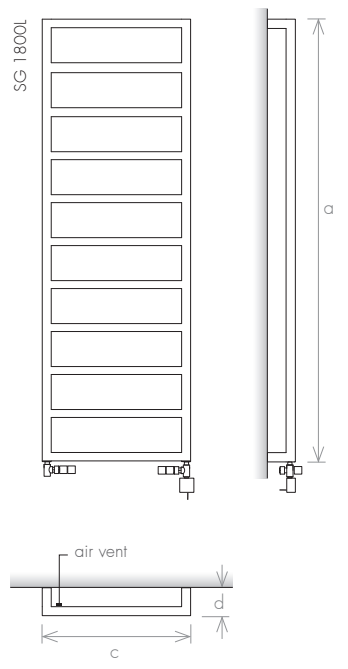





STEEL ELEGANCE

TOWEL WARMER

FINISHINGS

-  Polished
-  Brushed

ACCESSORIES

-  Domotic Touch
-  Mimoo Switch
-  Mimoo Switch Round

VERSION

-  Central Heating
-  Electric

MATERIAL

-  Stainless Steel

VERSION: ELECTRIC IV

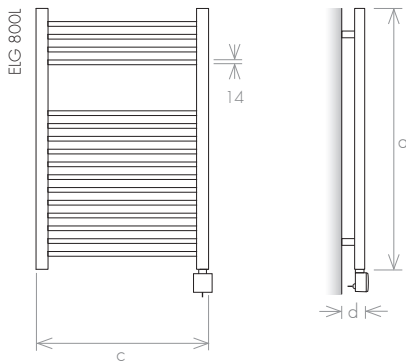

VERSION: CENTRAL HEATING

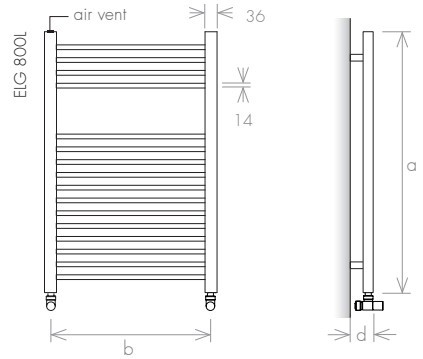

VERSION: ELECTRIC V

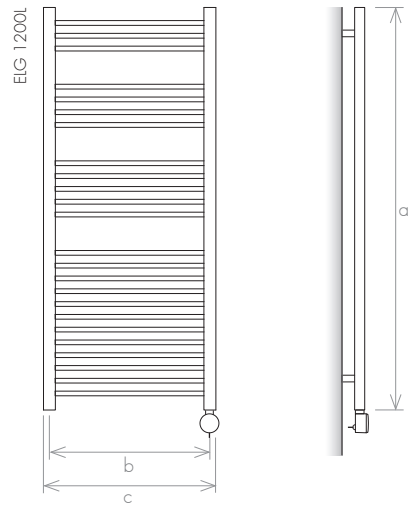

	model	ELG 800E	ELG 800L	ELG 1200E	ELG 1200L	ELG 1800E	ELG 1800L
height (mm)	a	800	800	1200	1200	1800	1800
width between axles (mm)	b	450	500	450	500	450	500
total width (mm)	c	480	530	480	530	480	530
depth (mm)	d	87	87	87	87	87	87
capacity (l)		1,6	1,8	2,4	2,7	3,3	3,7
central heating (W)		144	160	216	240	377	419
electric (W)		200	200	300	300	600	600





FOURFOZ

TOWEL WARMER

ARCHITECT: EDUARDO SOUTO DE MOURA







FINISHINGS

-  Polished
-  Brushed
-  Textured Black
-  White 9016 Satin
-  RAL Colour



PVD FINISHING

-  Champagne
-  Gold
-  Copper
-  Gun Metal

ACCESSORIES

-  Domotic Touch
-  Mimoo Switch
-  Mimoo Switch Round
-  Wall Valve

VERSION

-  Central Heating
-  Electric
-  Mixed

MATERIAL

-  Stainless Steel

VERSION: CENTRAL HEATING

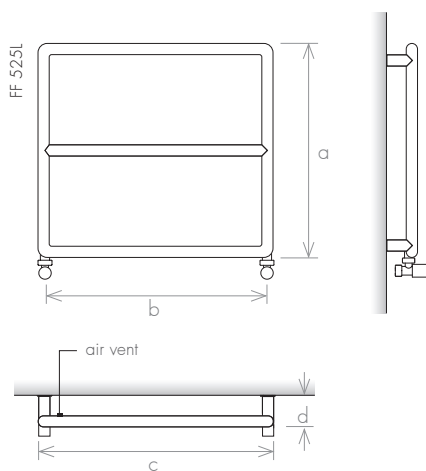

VERSION: ELECTRIC II

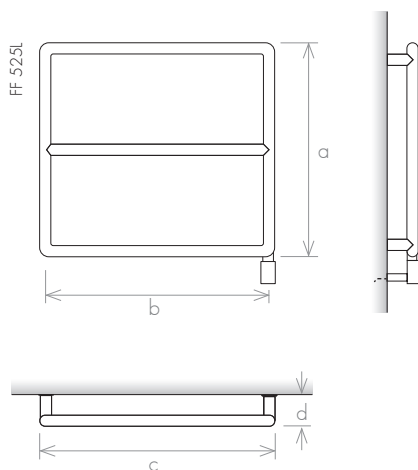

model		FF 525E	FF 525L	FF 800E	FF 800L
height (mm)	a	525	525	800	800
width between axles (mm)	b	450	500	450	500
total with (mm)	c	475	525	475	525
depth (mm)	d	100	100	100	100
capacity (l)		0,8	0,8	1,0	1,2
central heating (W)		89	98	126	139
electric (W)		100	100	150	150



FOURFOZ ON OFF

TOWEL WARMER

ARCHITECT: EDUARDO SOUTO DE MOURA



model		FFO 525E	FFO 525L	FFO 800E	FFO 800L
height (mm)	a	525	525	800	800
width between axles (mm)	b	450	500	450	500
total with (mm)	c	475	525	475	525
depth (mm)	d	100	100	100	100
electric (W)		100	100	150	150

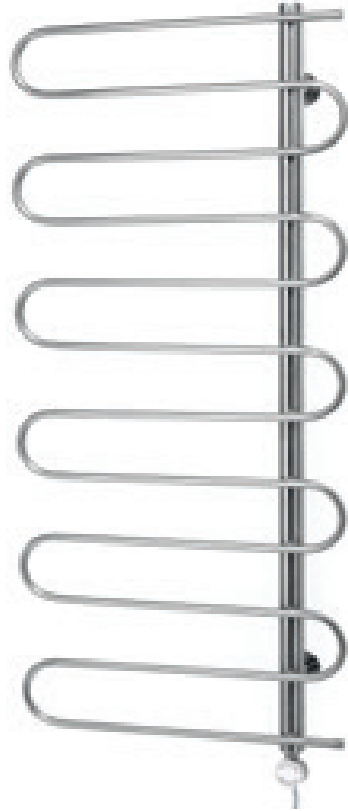
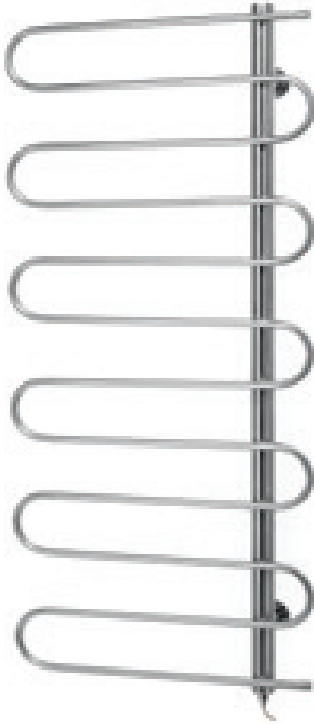

STEEL WAVE

TOWEL WARMER

FINISHINGS

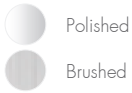

ACCESSORIES



VERSION

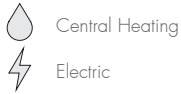

MATERIAL



VERSION: ELECTRIC II

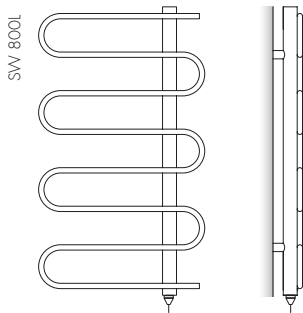

VERSION: CENTRAL HEATING

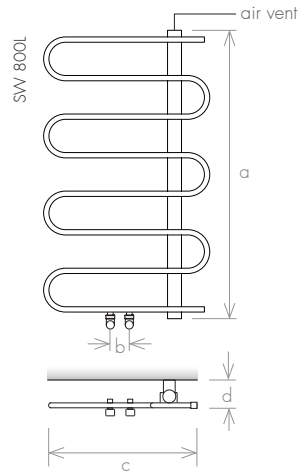

VERSION: ELECTRIC V

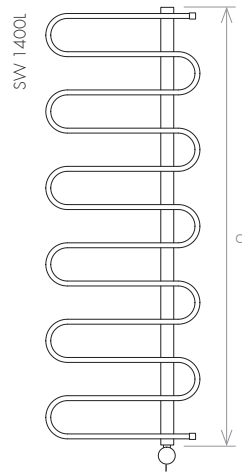



model		SW800L	SW800XL	SW1200L	SW1200XL	SW1400L	SW1400XL
height	(mm) a	868	868	1100	1100	1332	1332
width between axles	(mm) b	50	50	50	50	50	50
total width	(mm) c	500	600	500	600	500	600
depth	(mm) d	90	90	90	90	90	90
capacity	(l)	3,1	3,5	4,0	4,6	6,1	6,9
central heating	(W)	279	317	360	438	545	616
electric	(W)	200	200	300	300	600	600

STEEL STONE

TOWEL WARMER





FINISHINGS

-  Polished
-  Brushed

ACCESSORIES

-  Domotic Touch
-  Mimoo Switch
-  Mimoo Switch Round

VERSION

-  Central Heating
-  Electric

MATERIAL

-  Stainless Steel

The covering material should support temperatures up to 120 °C.

Recommended material: natural stones, like marble and granite.

Stone not included.

VERSION: CENTRAL HEATING

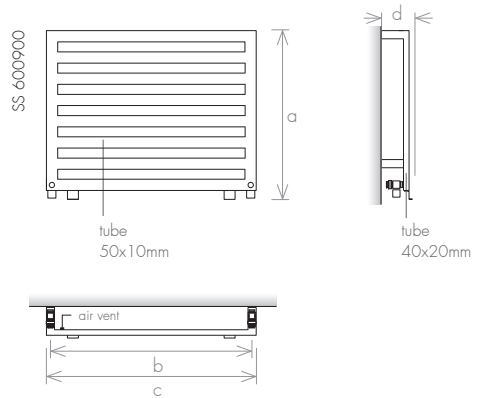

VERSION: ELECTRIC II

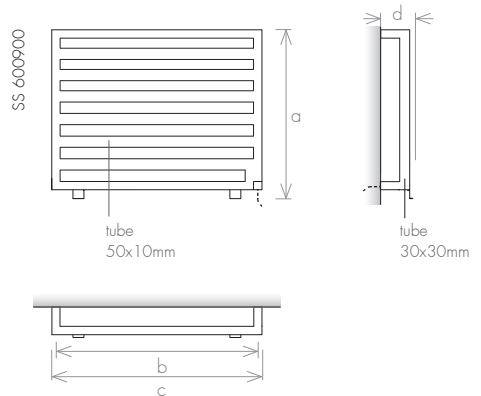



model		SS600600	SS400900	SS600900	SS4001200	SS6001200	SS8001200
height (mm)	a	600	400	600	400	600	800
width between axles (mm)	b	560	860	860	1160	1160	1160
total width (mm)	c	600	900	900	1200	1200	1200
depth (mm)	d	110	110	110	110	110	110
capacity (l)		3,6	4,2	4,7	5,6	5,8	7,2
central heating (W)		322	379	419	500	524	647
electric (W)		300	300	600	600	600	1000



STEEL CLASSIC

TOWEL WARMER

FINISHINGS

-  Polished
-  Brushed

ACCESSORIES

-  Domotic Touch
-  Mimoo Switch
-  Mimoo Switch Round

VERSION

-  Central Heating
-  Electric

MATERIAL

-  Stainless Steel

VERSION: CENTRAL HEATING

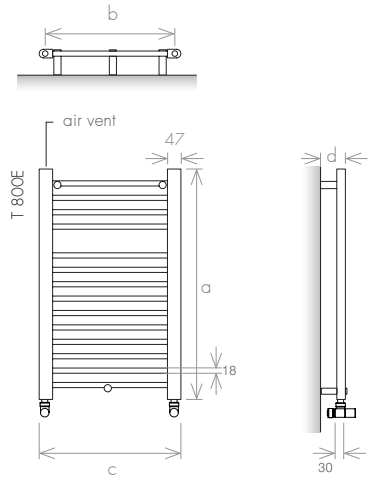

VERSION: ELECTRIC V

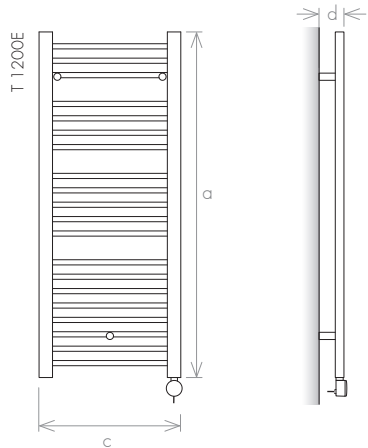



model		T 800E	T 800L	T 1200E	T 1200L	T 1800E	T 1800L
height (mm)	a	800	800	1200	1200	1800	1800
width between axles (mm)	b	450	500	450	500	450	500
total width (mm)	c	492	542	492	542	492	542
depth (mm)	d	87	87	87	87	87	87
capacity (l)		2,5	2,6	3,6	3,7	5,6	5,9
central heating (W)		221	234	323	353	497	547
electric (W)		200	200	300	300	600	600



STEEL GLAMOUR

TOWEL WARMER

FINISHINGS

-  Polished
-  Brushed

ACCESSORIES

-  Domotic Touch
-  Mimoo Switch
-  Mimoo Switch Round

VERSION

-  Central Heating
-  Electric

MATERIAL

-  Stainless Steel

VERSION: CENTRAL HEATING

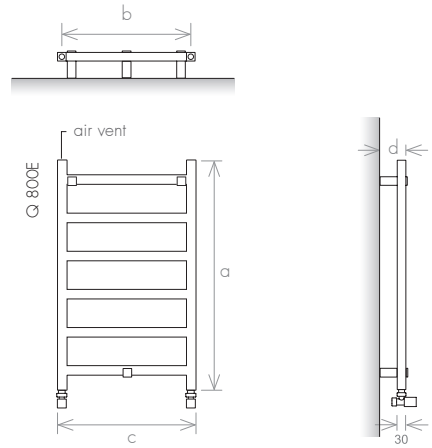

VERSION: ELECTRIC II

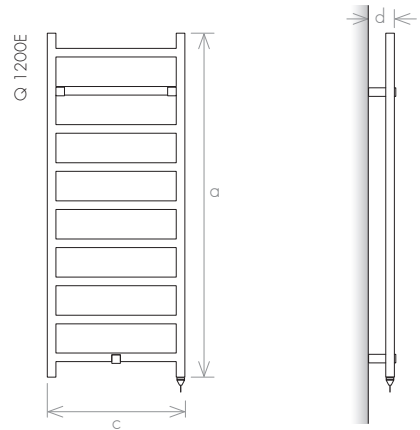



model		Q 800E	Q 800L	Q 1200E	Q 1200L	Q 1800E	Q 1800L
height (mm)	a	800	800	1200	1200	1800	1800
width between axles (mm)	b	450	500	450	500	450	500
total width (mm)	c	480	530	480	530	480	530
depth (mm)	d	90	90	90	90	90	90
capacity (l)		2,8	3,1	4,0	4,6	6,9	7,4
central heating (W)		250	296	360	438	642	689
electric (W)		300	300	600	600	1000	1000



STEEL STYLE

TOWEL WARMER

FINISHINGS

-  Textured Black
-  White 9016 Satin

ACCESSORIES

-  Domotic Touch
-  Mimoo Switch
-  Mimoo Switch Round

VERSION

-  Central Heating
-  Electric

MATERIAL

-  Steel

VERSION: CENTRAL HEATING

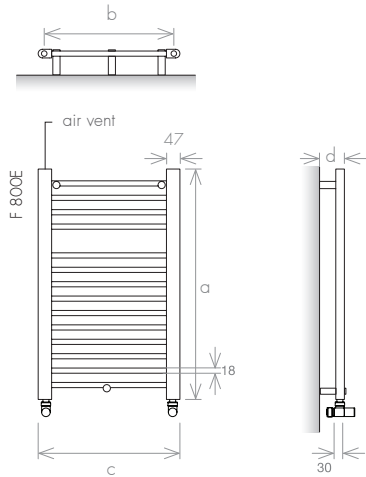

VERSION: ELECTRIC V

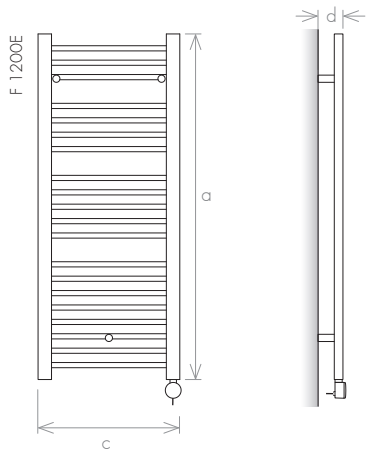





	model	F 800E	F 800L	F 1200E	F 1200L	F 1800E	F 1800L
height (mm)	a	800	800	1200	1200	1800	1800
width between axles (mm)	b	450	500	450	500	450	500
total width (mm)	c	492	542	492	542	492	542
depth (mm)	d	87	87	87	87	87	87
capacity (l)		2,5	2,5	3,6	3,7	5,6	5,9
central heating (W)		221	234	323	353	497	547
electric (W)		200	200	300	300	600	600



NEW SLIM

TOWEL WARMER



FINISHINGS

-  Polished
-  Brushed
-  Textured Black
-  White 9016 Satin
-  RAL Colour

ACCESSORIES

-  Domotic Touch
-  Mimoo Switch
-  Mimoo Switch Round

VERSION

-  Central Heating
-  Electric
-  Mixed

MATERIAL

-  Stainless Steel
-  Steel

VERSION: ELECTRIC IV OR V

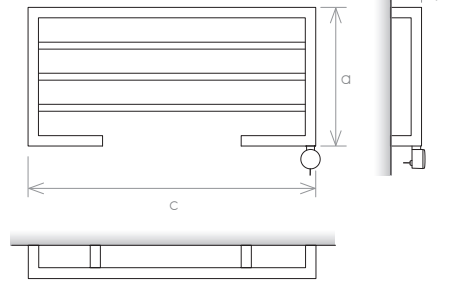

VERSION: CENTRAL HEATING

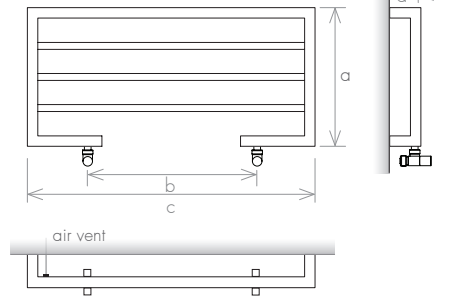

VERSION: MIXED

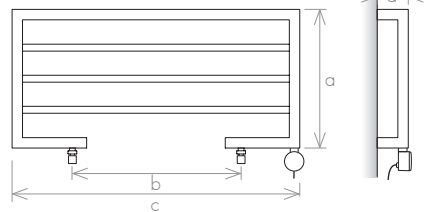





		central heating		electric
model		NS 400 E	NS 400 L	NS 400
height (mm)	a	400	400	400
width between axles (mm)	b	450	500	-
total width (mm)	c	830	830	830
depth (mm)	d	90	90	90
capacity (l)		2,1	2,1	2,1
central heating (W)		242	242	-
electric (W)		-	-	200

BASIC LINE

TOWEL WARMER





FINISHINGS

-  Polished
-  Brushed
-  Textured Black
-  White 9016 Satin
-  RAL Colour

ACCESSORIES

-  Domotic Touch
-  Mimoo Switch
-  Mimoo Switch Round

VERSION

-  Central Heating
-  Electric
-  Mixed

MATERIAL

-  Stainless Steel
-  Steel

VERSION: CENTRAL HEATING

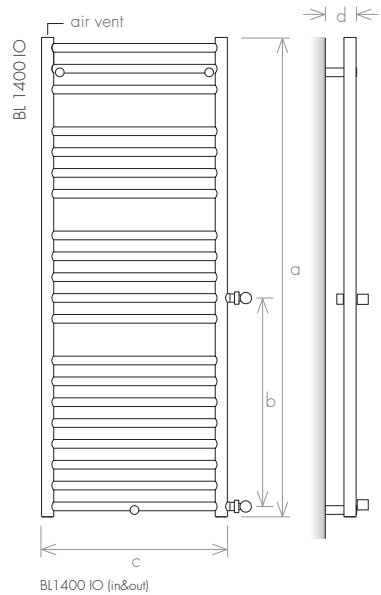
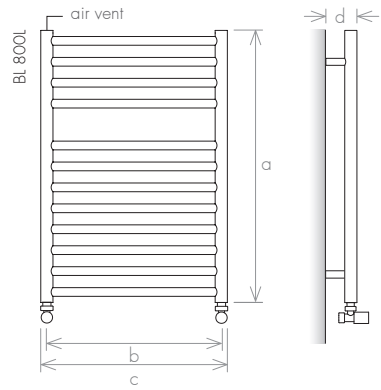



BL800E	BL800L	BL800XL	BL1200E	BL1200L	BL1200XL	model
780	780	780	1200	1200	1200	a (mm) height
450	500	600	450	500	600	b (mm) width between axles
485	535	635	485	535	635	c (mm) total width
90	90	90	90	90	90	d (mm) depth
2,90	3,16	3,68	4,19	4,56	5,29	(l) capacity
259,1	282,2	328,5	374,4	407,1	472,7	(W) central heating
300	300	300	600	600	600	(W) electric

VERSION: ELECTRIC II - STANDARD

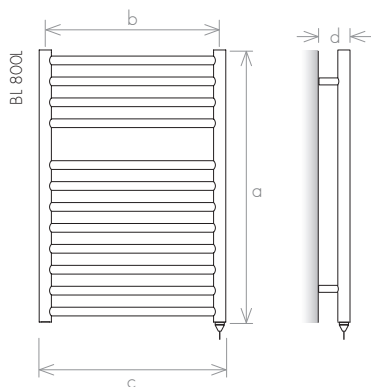

VERSION: MIXED

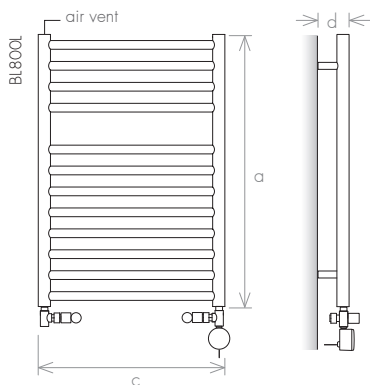

VERSION: ELECTRIC V

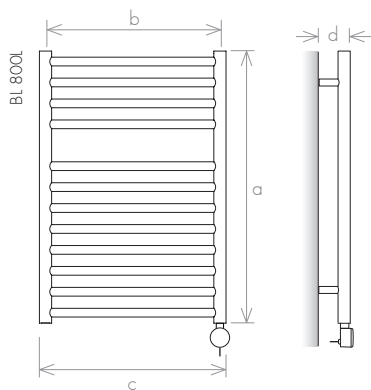

VERSION: ELECTRIC II (HIDDEN)

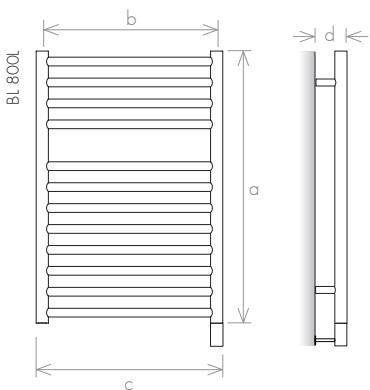



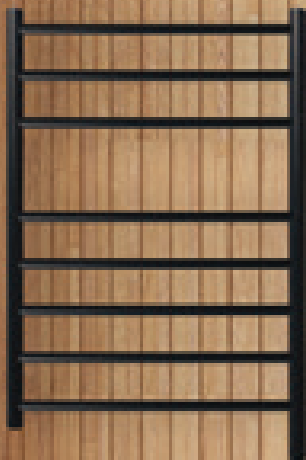

model		BL1400E	BL1400L	BL1400XL	BL1400 IO	BL1800E	BL1800L	BL1800XL
height (mm)	a	1380	1380	1380	1380	1800	1800	1800
width between axes (mm)	b	450	500	600	600	450	500	600
total width (mm)	c	485	535	635	535	485	535	635
depth (mm)	d	90	90	90	90	90	90	90
capacity (l)		4,90	5,33	6,19	5,33	6,55	7,14	8,30
central heating (W)		437,8	476,2	553,0	476,2	585,5	637,5	741,7
electric (W)		600	600	600	-	1000	1000	1000
electric III (W)						900	900	900

NEW BASIC

TOWEL WARMER





FINISHINGS

-  Polished
-  Brushed
-  Textured Black
-  White 9016 Satin
-  RAL Colour

ACCESSORIES

-  Domotic Touch
-  Mimoo Switch
-  Mimoo Switch Round

VERSION

-  Central Heating
-  Electric
-  Mixed

MATERIAL

-  Stainless Steel
-  Steel

VERSION: MIXED

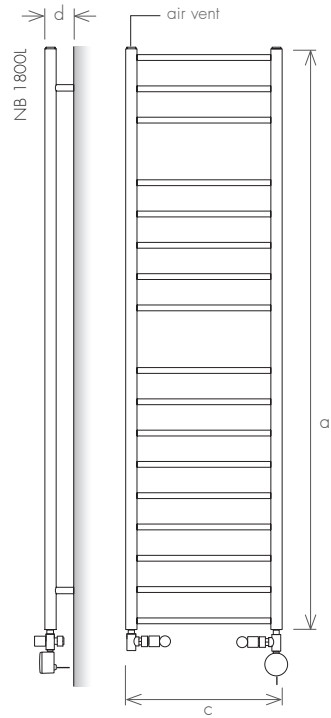

VERSION: CENTRAL HEATING

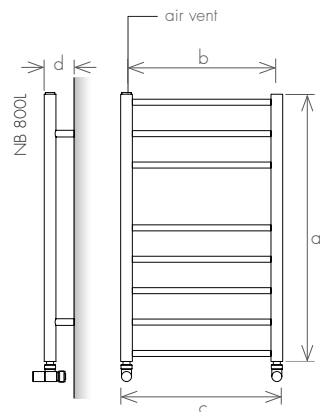

VERSION: ELECTRIC II - STANDARD

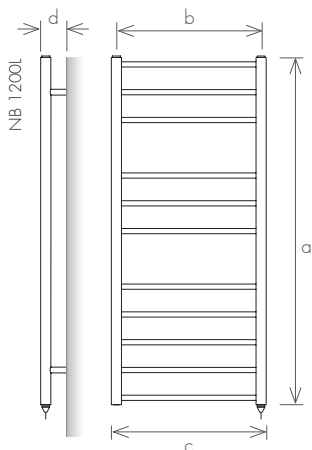

VERSION: ELECTRIC II (HIDDEN)

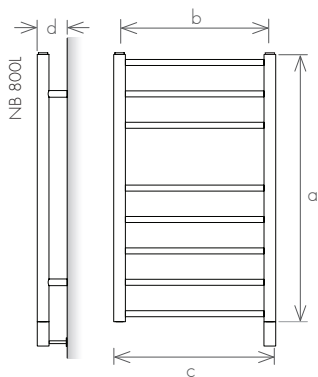

NB800E	NB800L	NB800XL	NB1200E	NB1200L	NB1200XL	model
800	800	800	1200	1200	1200	a (mm) height
450	500	600	450	500	600	b (mm) width between axles
485	535	635	485	535	635	c (mm) total width
90	90	90	90	90	90	d (mm) depth
2,5	2,5	2,7	3,6	3,7	3,9	(l) capacity
218	226	293	318	329	351	(W) central heating
200	200	200	300	300	300	(W) electric
150	150	150				(W) electric III

VERSION: CENTRAL HEATING

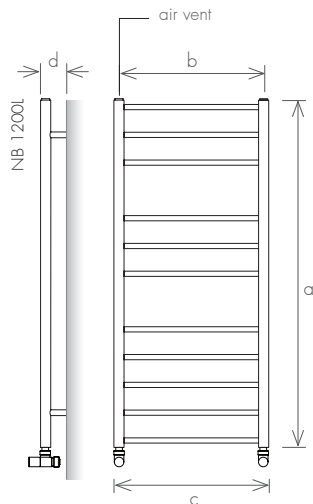

VERSION: ELECTRIC V

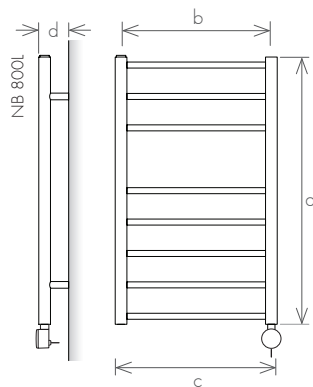

model		NB1400E	NB1400L	NB1400XL	NB1400I	NB1800E	NB1800L	NB1800XL
height (mm)	a	1448	1448	1448	1448	1800	1800	1800
width between axes (mm)	b	450	500	600	500	450	500	600
total width (mm)	c	485	535	635	535	485	535	635
depth (mm)	d	90	90	90	90	90	90	90
capacity (l)		4,3	4,5	4,8	4,5	5,4	5,6	6,0
central heating (W)		381	396	423	396	481	499	532
electric (W)		300	300	300	-	600	600	600



Empress
TOWEL WARMER

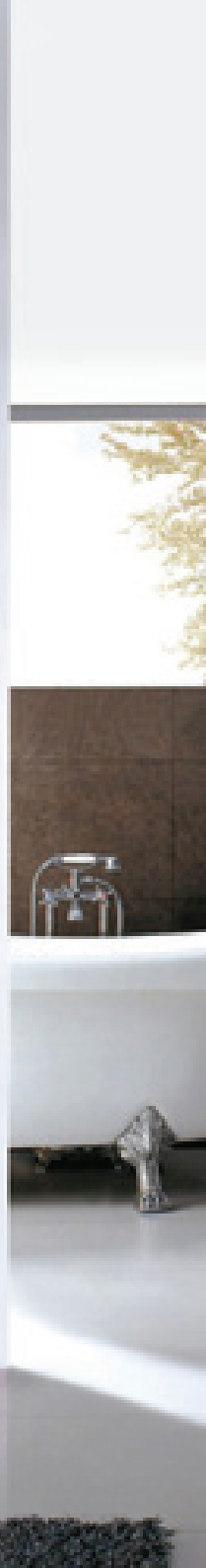

FINISHINGS

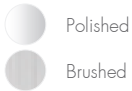

PVD FINISHING
maximum dimensions of 1000mm



ACCESSORIES

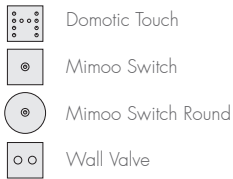

VERSION

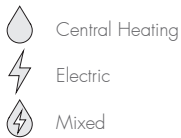

MATERIAL



VERSION: ELECTRIC II (HIDDEN)

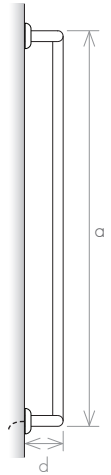
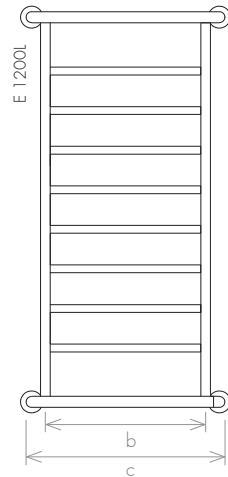

VERSION: MIXED

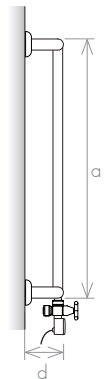
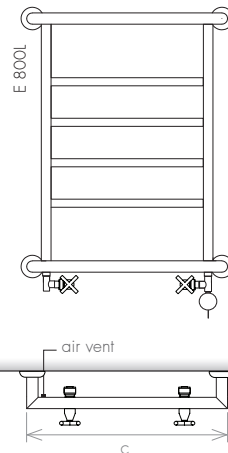



model		E 800E	E 800L	E 1200E	E 1200L	E 1800E	E 1800L
height (mm)	a	800	800	1200	1200	1800	1800
width between axles (mm)	b	450	500	450	500	450	500
total width (mm)	c	570	620	570	620	570	620
depth (mm)	d	120	120	120	120	120	120
capacity (l)		2,22	2,29	3,27	3,41	4,49	4,70
central heating (W)		200	206	294	307	404	423
electric (W)		200	200	300	300	600	600



Old Beauty
TOWEL WARMER





FINISHINGS

-  Polished
-  Brushed



PVD FINISHING
maximum dimensions of 1000mm

-  Champagne
-  Gold
-  Copper
-  Gun Metal

ACCESSORIES

-  Domotic Touch
-  Mimoo Switch
-  Mimoo Switch Round
-  Wall Valve

VERSION

-  Central Heating
-  Electric
-  Mixed

MATERIAL

-  Stainless Steel

VERSION: CENTRAL HEATING

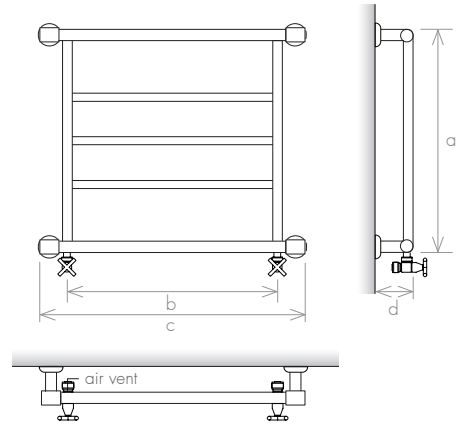

VERSION: ELECTRIC II (HIDDEN)

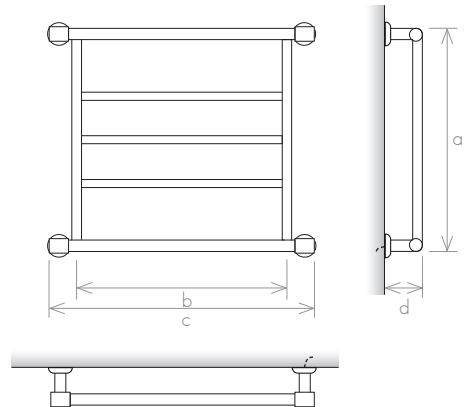

model		OB 800
height (mm)	a	690
width between axles (mm)	b	650
total width (mm)	c	820
depth (mm)	d	120
capacity (l)		2,61
central heating (W)		235
electric (W)		600



Remind

TOWEL WARMER

FINISHINGS

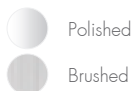

PVD FINISHING
maximum dimensions of 1000mm



ACCESSORIES

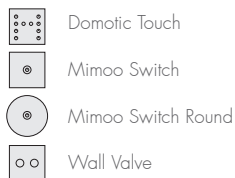

VERSION

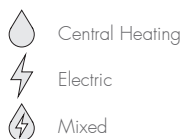

MATERIAL



VERSION: CENTRAL HEATING

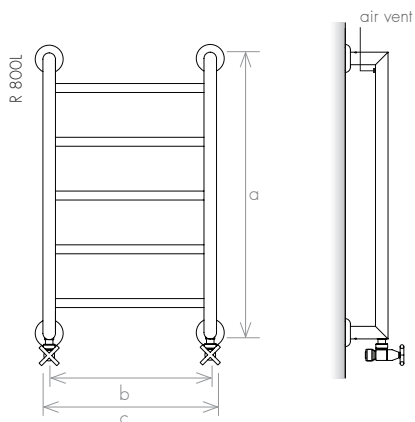

VERSION: ELECTRIC II (HIDDEN)

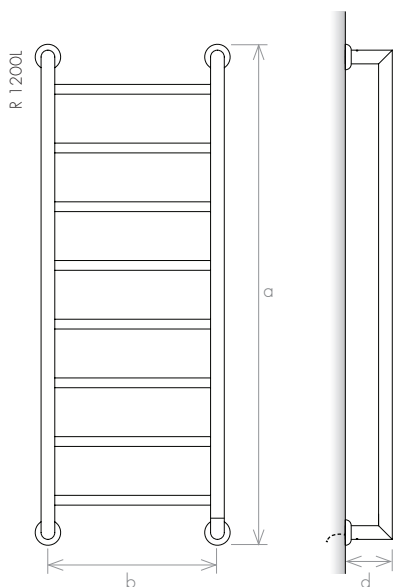



	model	R 800E	R 800L	R 1200E	R 1200L	R 1800E	R 1800L
height (mm)	a	800	800	1250	1250	1850	1850
width between axles (mm)	b	450	500	450	500	450	500
total width (mm)	c	485	535	485	535	485	535
depth (mm)	d	120	120	120	120	120	120
capacity (l)		1,84	1,93	2,90	3,03	4,31	4,51
central heating (W)		165	174	261	272	387	405
electric (W)		200	200	300	300	600	600



Floor Remind

TOWEL WARMER

FINISHINGS

-  Polished
-  Brushed



PVD FINISHING
maximum dimensions of 1000mm

-  Champagne
-  Gold
-  Copper
-  Gun Metal

ACCESSORIES

-  Domotic Touch
-  Mimoo Switch
-  Mimoo Switch Round

VERSION

-  Central Heating
-  Electric

MATERIAL

-  Stainless Steel

VERSION: CENTRAL HEATING

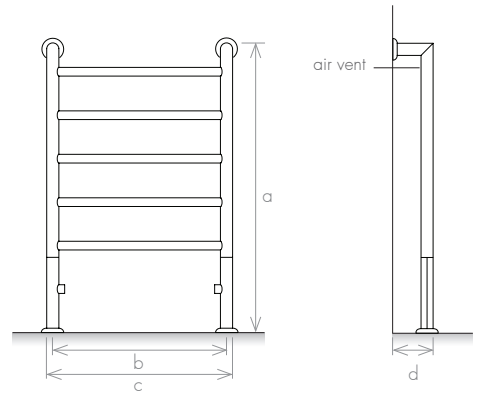

VERSION: ELECTRIC II (HIDDEN)

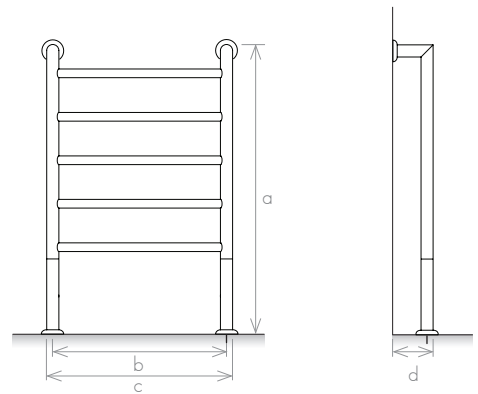

model		FR 1000	FR 1200	FR 1400
height (mm)	a	1000	1200	1400
width between axles (mm)	b	600	600	600
total width (mm)	c	642	642	642
depth (mm)	d	140	140	140
capacity (l)		3,69	4,26	5,17
central heating (W)		332	398	465
electric (W)		300	300	600





Retro Special

TOWEL WARMER



model	RE600400	RE600450	RE600500	RE600600	RE800400	RE800450
height (mm) a	600	600	600	600	800	800
width between axles (mm) b	400	450	500	600	400	450
total width (mm) c	435	485	535	635	435	485
depth (mm) d	90	90	90	90	90	90
capacity (l)	1,35	1,41	1,47	1,58	1,67	1,73
central heating (W)	101	106	111	122	120	126
electric (W)	150	150	150	200	200	200



FINISHINGS

-  Polished
-  Brushed
-  Textured Black
-  White 9016 Satin
-  RAL Colour



PVD FINISHING
maximum dimensions of 1000mm

-  Champagne
-  Gold
-  Copper
-  Gun Metal

ACCESSORIES

-  Domotic Touch
-  Mimoo Switch
-  Mimoo Switch Round

VERSION

-  Central Heating
-  Electric
-  Mixed

MATERIAL

-  Stainless Steel
-  Steel

VERSION: ELECTRIC II

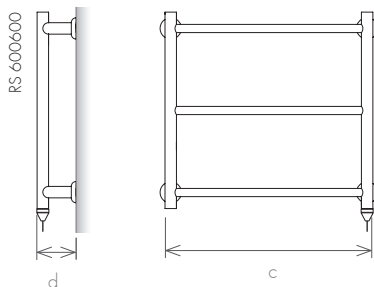

VERSION: ELECTRIC IV OR V

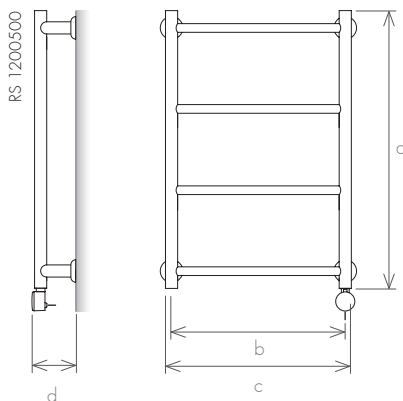



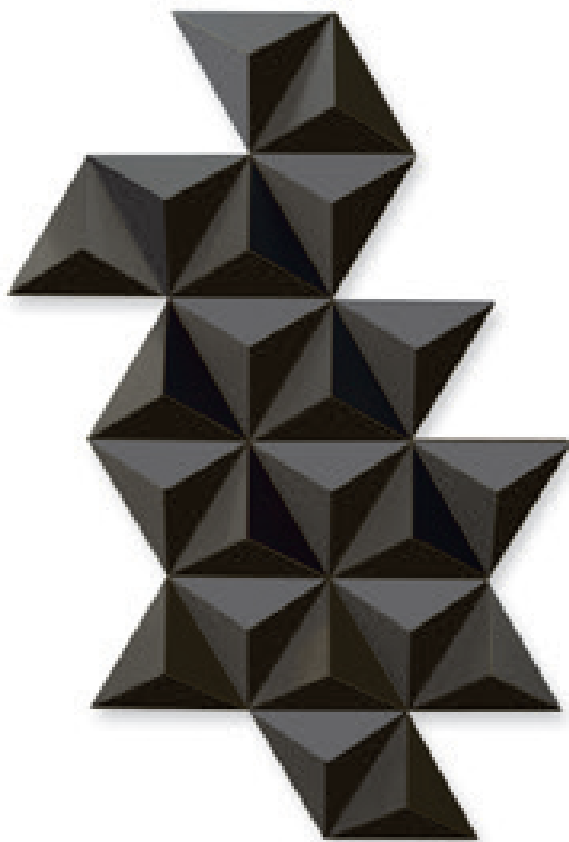

RE800500	RE800600	RE1000400RE	1000450	RE1000500	RE1000600	RE1200400	RE1200450	RE1200500	RE1200600
800	800	1000	1000	1000	1000	1200	1200	1200	1200
500	600	400	450	500	600	400	450	500	600
535	635	435	485	535	635	435	485	535	635
90	90	90	90	90	90	90	90	90	90
1,79	1,9	2,12	2,2	2,28	2,43	2,45	2,52	2,6	2,75
131	142	154	161	168	182	174	181	188	202
200	200	300	300	300	300	300	300	300	300



DIAMOND

DESIGN RADIATOR
DESIGNER: PATRICK PEDROSA





FINISHINGS

-  Polished
-  Brushed
-  Textured Black
-  White 9016 Satin
-  RAL Colour

PVD FINISHING
maximum dimensions of 1000mm

-  Champagne
-  Gold
-  Copper
-  Gun Metal

ACCESSORIES

-  Domotic Touch
-  Mimoo Switch
-  Mimoo Switch Round
-  Wall Valve

VERSION

-  Central Heating
-  Electric

MATERIAL

-  Stainless Steel
-  Steel

VERSION: CENTRAL HEATING

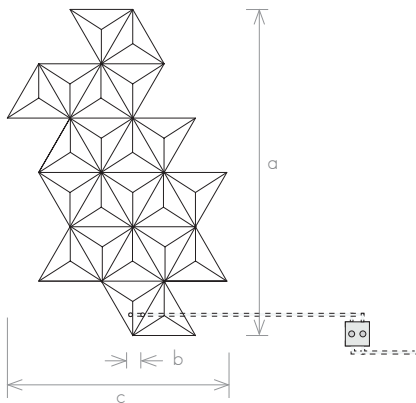

VERSION: ELECTRIC II (HIDDEN)

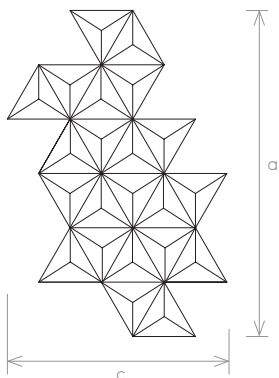

model		D 1500V	D 1200H
height (mm)	a	1560	1050
width between axes (mm)	b	50	50
total width (mm)	c	1050	1560
depth (mm)		110	110
capacity (l)		11,18	11,18
weight (kg)		≈ 75	≈ 75
central heating (W)		1205	1205
electric (W)		1600-2000	1600-2000

DIAMOND XS

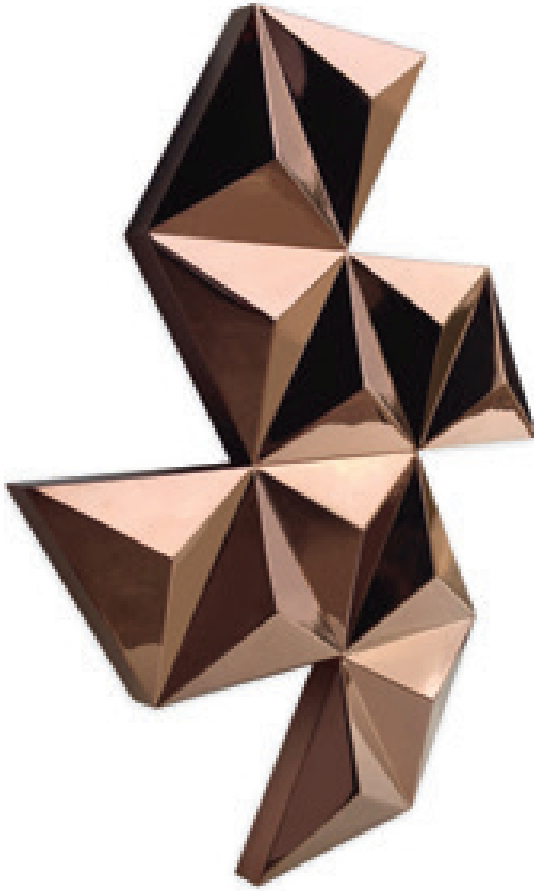

D XS	model
1040	a (mm) height
50	b (mm) width between axles
900	c (mm) total width
110	d (mm) depth
4,75	(l) capacity
≈ 35	(kg) weight
568	(W) central heating
600-1000	(W) electric

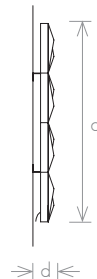

ARENA TABLE

DESIGN RADIATOR

DESIGNER: PATRICK PEDROSA

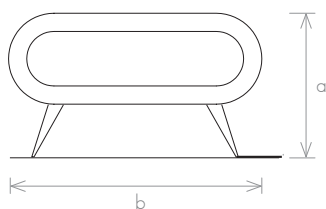
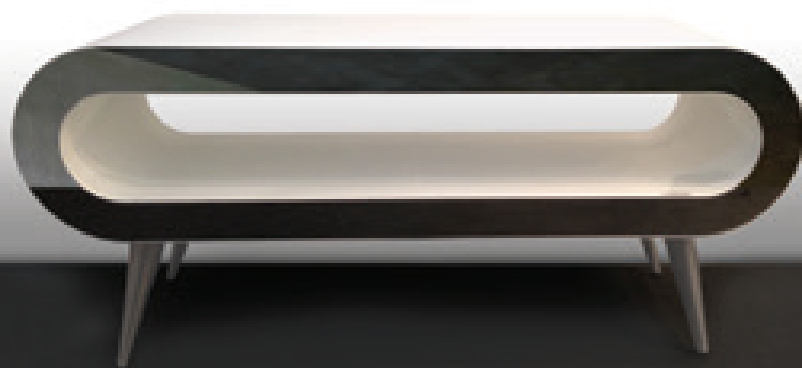

model		AT 1000	AT 1200	AT 1400
height (mm)	a	535	535	535
total width (mm)	b	1000	1200	1400
depth (mm)		450	450	450
capacity (l)		7,45	10,89	12,66
weight (kg)		~50	~65	~75
electric (W)		1000	1500	1500





ARENA

DESIGN RADIATOR

DESIGNER: PATRICK PEDROSA







FINISHINGS

-  Polished
-  Brushed
-  Textured Black
-  White 9016 Satin
-  RAL Colour



PVD FINISHING
maximum dimensions of 1000mm

-  Champagne
-  Gold
-  Copper
-  Gun Metal

ACCESSORIES

-  Domotic Touch
-  Mimoo Switch
-  Mimoo Switch Round
-  Wall Valve

VERSION

-  Central Heating
-  Electric

MATERIAL

-  Stainless Steel
-  Steel

VERSION: CENTRAL HEATING

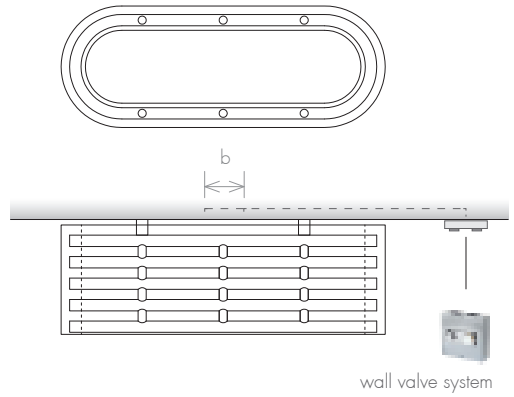

VERSION: ELECTRIC II

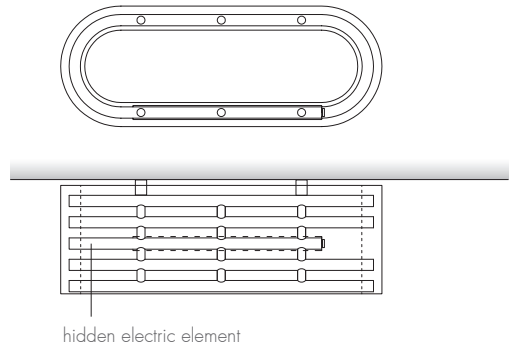

model		A 800	A 1200	A 1400
height (mm)	a	300	300	300
width between axles (mm)	b	50	50	50
total width (mm)	c	800	1200	1400
depth (mm)	d	270	270	270
capacity (l)		5,32	7,78	9,04
weight (kg)		~30	~45	~55
central heating (W)		578	801	913
electric (W)		600	1000	1500

CURVE

ROOM RADIATOR







electric

C2301000 C2301500 C2302000 C3001000 C3001500 C3002000

model

230	230	230	300	300	300	a (mm)	height
1000	1500	2000	1000	1500	2000	b (mm)	total width
160	160	160	160	160	160	c (mm)	depth
1,3	2,1	2,9	1,3	2,1	2,9	d (mm)	capacity
1600	1800	2000	1600	1800	2000	(W)	electric



FINISHINGS

-  Polished
-  Brushed
-  Textured Black
-  White 9016 Satin
-  RAL Colour

ACCESSORIES

-  Domotic Touch
-  Mimoo Switch
-  Mimoo Switch Round

VERSION

-  Central Heating
-  Electric

MATERIAL

-  Stainless Steel
-  Steel

VERSION: ELECTRIC WITH HIDDEN ELEMENT II

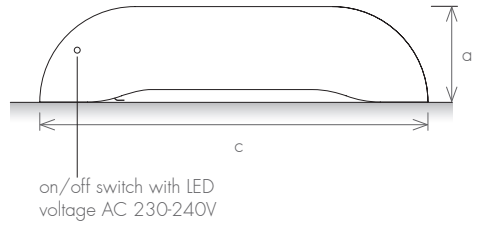

VERSION: CENTRAL HEATING

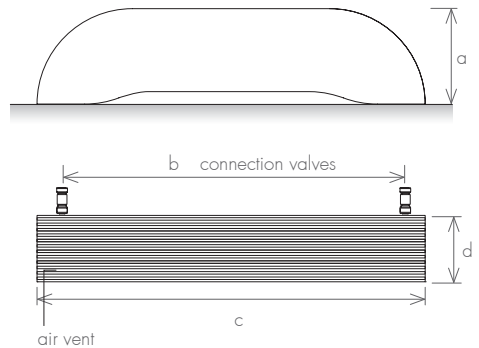

central heating

model	C2301000	C2301500	C2302000	C3001000	C3001500	C3002000
height (mm) a	230	230	230	300	300	300
total width (mm) b	1000	1500	2000	1000	1500	2000
depth (mm) c	160	160	160	160	160	160
width between axles (mm) d	800	1300	1800	800	1300	1800
central heating (W)	872	1343	1787	1308	2015	2480

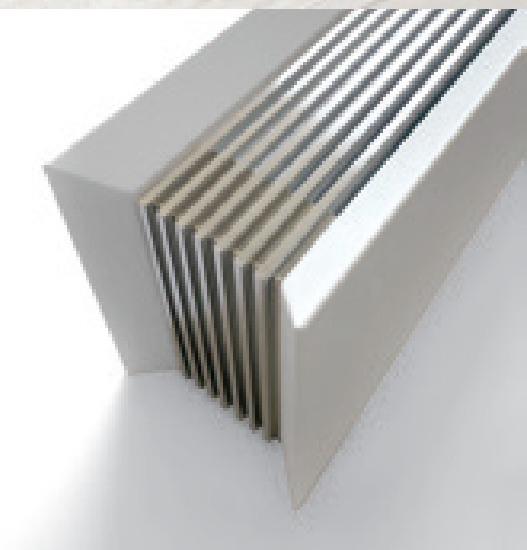

D LIGNE

ROOM RADIATOR





electric

DL2301000 DL2301500 DL2302000 DL3001000 DL3001500 DL3002000

model

230	230	230	300	300	300	a (mm)	height
1000	1500	2000	1000	1500	2000	b (mm)	total width
160	160	160	160	160	160	c (mm)	depth
1,4	2,2	3,0	1,4	2,2	3,0	d (mm)	capacity
1600	1800	2000	1600	1800	2000	(W)	electric



FINISHINGS

-  Polished
-  Brushed
-  Textured Black
-  White 9016 Satin
-  RAL Colour

ACCESSORIES

-  Domotic Touch
-  Mimoo Switch
-  Mimoo Switch Round

VERSION

-  Central Heating
-  Electric

MATERIAL

-  Stainless Steel
-  Steel

VERSION: ELECTRIC WITH HIDDEN ELEMENT II

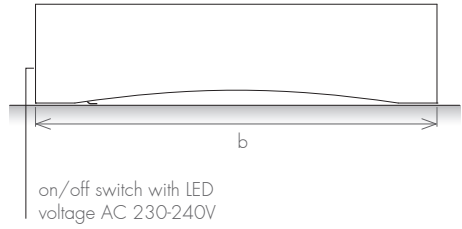

VERSION: CENTRAL HEATING

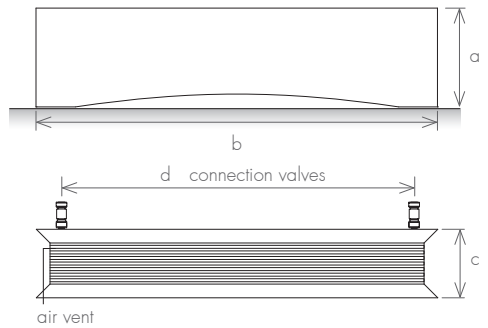

central heating

model	DL2301000	DL2301500	DL2302000	DL3001000	DL3001500	DL3002000
height (mm) a	230	230	230	300	300	300
total width (mm) b	1000	1500	2000	1000	1500	2000
depth (mm) c	160	160	160	160	160	160
width between axles (mm) d	860	1360	1860	860	1360	1860
central heating (W)	948	1460	1942	1422	2190	2913

DIVINE



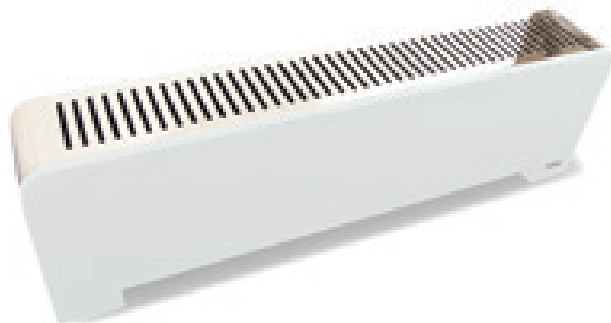

RADIATOR



electric

DI 1000	DI 1500	DI 2000	DI30 1000	DI30 1500	DI30 2000	model
230	230	230	300	300	300	a (mm) height
1000	1500	2000	1000	1500	2000	b (mm) total width
160	160	160	160	160	160	c (mm) depth
1,4	2,2	3,0	1,4	2,2	3,0	d (mm) capacity
1600	1800	2000	1600	1800	2000	(W) electric

FINISHINGS

-  Polished
-  Brushed
-  Textured Black
-  White 9016 Satin
-  RAL Colour

ACCESSORIES

-  Domotic Touch
-  Mimoo Switch
-  Mimoo Switch Round

VERSION

-  Central Heating
-  Electric

MATERIAL

-  Stainless Steel
-  Steel

VERSION: ELECTRIC WITH HIDDEN ELEMENT II

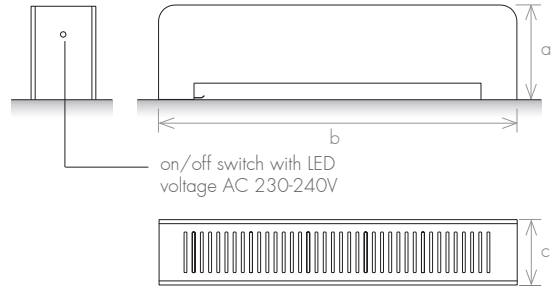

VERSION: CENTRAL HEATING

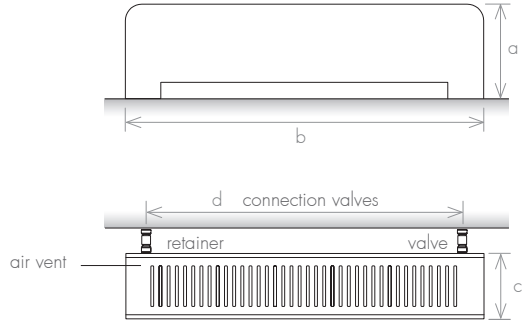

central heating

model	DI 1000	DI 1500	DI 2000	DI30 1000	DI30 1500	DI30 2000
height (mm) a	230	230	230	300	300	300
total width (mm) b	1000	1500	2000	1000	1500	2000
depth (mm) c	160	160	160	160	160	160
width between axles (mm) d	880	1380	1880	880	1380	1880
central heating (W)	948	1460	1942	1422	2190	2913







LINEAR

ROOM RADIATOR

electric

LE 1000	LE 1500	LE 1000+	LE 1500+	LE 2000+	LE30 1000	LE30 1500	LE30 2000	model
240	240	240	240	240	310	310	310	a (mm) height
1000	1500	1000	1500	2000	1000	1500	2000	b (mm) total width
100	100	160	160	160	160	160	160	c (mm) depth
1,4	2,2	1,4	2,2	3,0	1,4	2,2	3,0	d (mm) capacity
1600	1800	1600	1800	2000	1600	1800	2000	(W) electric



FINISHINGS

-  Polished
-  Brushed
-  Textured Black
-  White 9016 Satin
-  RAL Colour

ACCESSORIES

-  Domotic Touch
-  Mimoo Switch
-  Mimoo Switch Round

VERSION

-  Central Heating
-  Electric

MATERIAL

-  Stainless Steel
-  Steel

VERSION: ELECTRIC WITH HIDDEN ELEMENT II

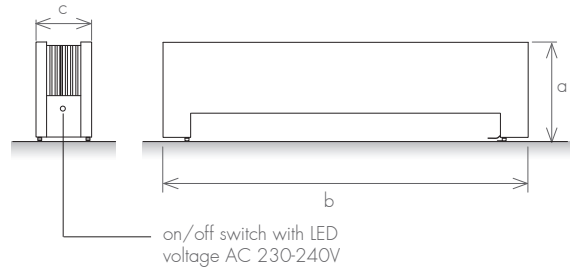

VERSION: CENTRAL HEATING

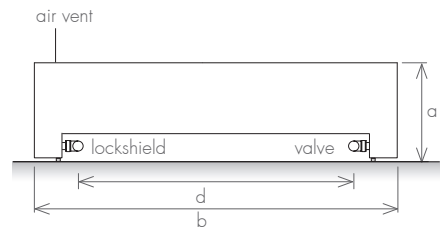

central heating

model	LC 1000	LC 1500	LC 2000	LC30 1000	LC30 1500	LC30 2000
height (mm) a	240	240	240	310	310	310
total width (mm) b	1000	1500	2000	1000	1500	2000
depth (mm) c	160	160	160	160	160	160
width between axles (mm) d	-	-	-	-	-	-
central heating (W)	948	1460	1942	1422	2190	2913

PLANO MOVE



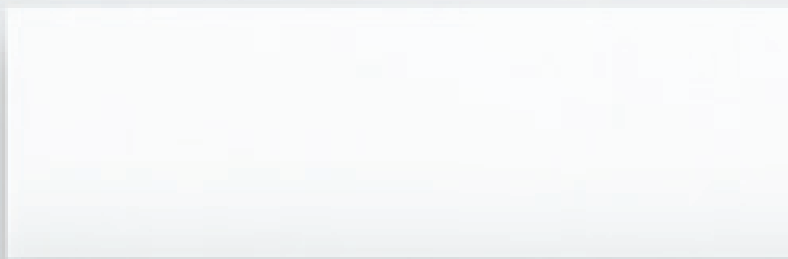

ROOM RADIATOR





model		PM400800	PM500800	PM600800	PM4001200	PM5001200	PM6001200	PM4001400
height (mm) a		400	500	600	400	500	600	400
total width (mm) c		800	800	800	1200	1200	1200	1400
depth (mm) d		40/60/90	40/60/90	40/60/90	40/60/90	40/60/90	40/60/90	40/60/90
electric (W)		300	300	600	600	600	600	600

model		PM800400	PM800500	PM800600	PM1200400	PM1200500	PM1200600	PM1400400
height (mm) a		800	800	800	1200	1200	1200	1400
total width (mm) c		400	500	600	400	500	600	400
depth (mm) d		40/60/90	40/60/90	40/60/90	40/60/90	40/60/90	40/60/90	40/60/90
electric (W)		300	300	600	600	600	600	600

FINISHINGS

-  Polished
-  Brushed
-  Textured Black
-  White 9016 Satin
-  RAL Colour

ACCESSORIES

-  Domotic Touch
-  Mimoo Switch
-  Mimoo Switch Round

VERSION

-  Electric

MATERIAL

-  Stainless Steel
-  Steel

NOTE

Electrical heating cartridge with thermal fluid

VERSION: ELECTRIC WITH HIDDEN ELEMENT II

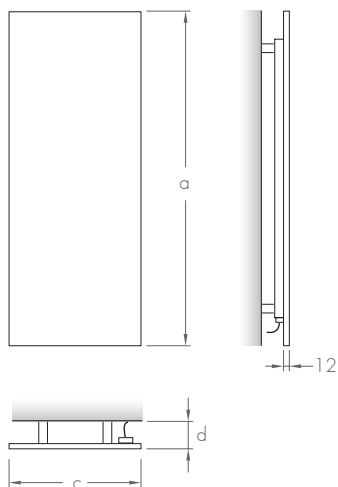
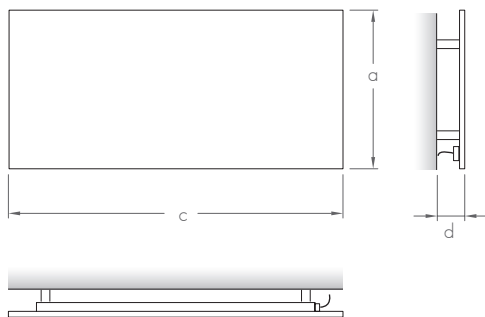

PM5001400	PM6001400	PM4001800	PM5001800	PM6001800	PM4002000	PM5002000	PM6002000
500	600	400	500	600	400	500	600
1400	1400	1800	1800	1800	2000	2000	2000
40/60/90	40/60/90	40/60/90	40/60/90	40/60/90	40/60/90	40/60/90	40/60/90
600	600	600	600	1000	1000	1000	1000
PM1400500	PM1400600	PM1800400	PM1800500	PM1800600	PM2000400	PM2000500	PM2000600
1400	1400	1800	1800	1800	2000	2000	2000
500	600	400	500	600	400	500	600
40/60/90	40/60/90	40/60/90	40/60/90	40/60/90	40/60/90	40/60/90	40/60/90
600	600	600	600	1000	1000	1000	1000

PLANO PURE





ROOM RADIATOR

* Different width between axles and positioning of valves according to the client's choice.

** The depth can be less than 80mm.

PP6501200	PP6501800	PP6502000	PP10001000	PP1800550	PP2000550	PP1800650	PP2000650	model
650	650	650	1000	1800	2000	1800	2000	a (mm) height
-	-	-	-	-	-	-	-	b (mm) * width between axles
1200	1800	2000	1000	550	550	650	650	c (mm) total width
80	80	80	80	80	80	80	80	d (mm) ** depth
26,03	33,31	36,99	28,96	27,88	28,96	33,31	36,99	(l) capacity
47,4	69,8	77,1	64,6	59,1	75,2	69,8	77,1	(kg) weight
2512	3768	4187	3382	3267	3630	3768	4187	(W) central heating
1200	1600	2000	1200	1600	2000	1600	2000	(W) electric II
-	-	-	-	1000	1000	1000	1000	(W) electric IV

FINISHINGS

-  Polished
-  Brushed
-  Textured Black
-  White 9016 Satin
-  RAL Colour

ACCESSORIES

-  Domotic Touch
-  Mimoo Switch
-  Mimoo Switch Round

VERSION

-  Central Heating
-  Electric

MATERIAL

-  Stainless Steel
-  Steel

VERSION: ELECTRIC II

VERSION: ELECTRIC IV

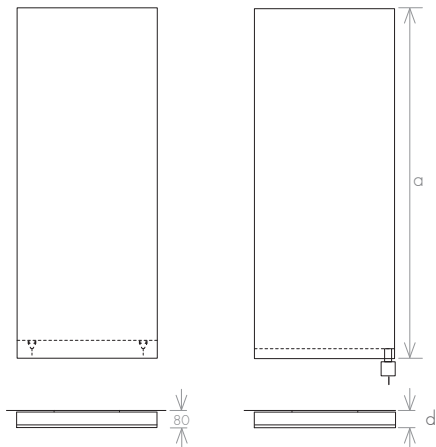

VERSION: ELECTRIC II

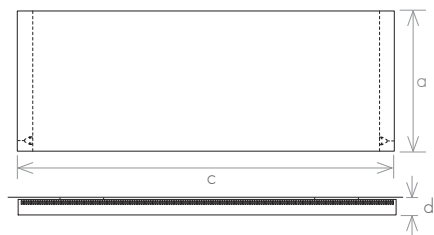

VERSION: CENTRAL HEATING

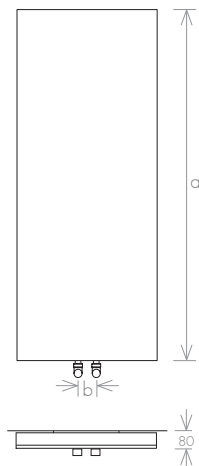

VERSION: CENTRAL HEATING

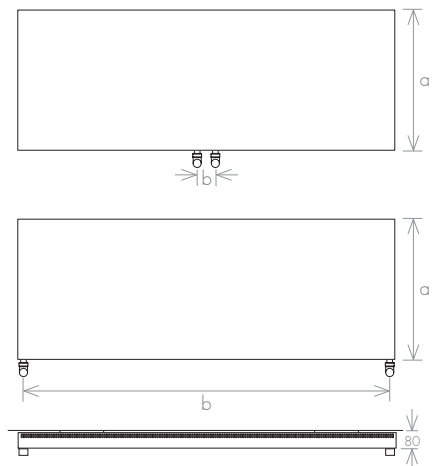







PLANO PURE ON/OFF



ROOM RADIATOR



FINISHINGS

-  Polished
-  Brushed
-  Textured Black
-  White 9016 Satin
-  RAL Colour

ACCESSORIES

-  Domotic Touch
-  Mimoo Switch
-  Mimoo Switch Round

VERSION

-  Electric

MATERIAL

-  Stainless Steel
-  Steel

VERSION: ELECTRIC II

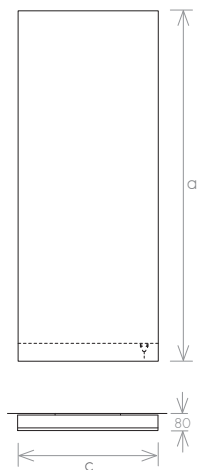

VERSION: ELECTRIC II

on/off switch with LED
voltage AC 230-240V

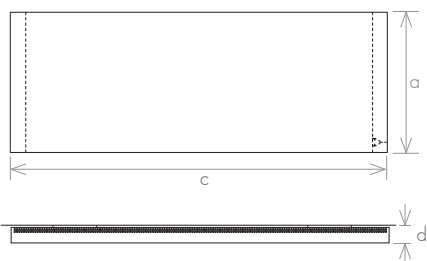
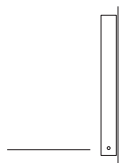

model		PP6501200	PP6501800	PP6502000	PP10001000	PP1800550	PP2000550	PP1800650	PP2000650
height (mm)	a	650	650	650	1000	1800	2000	1800	2000
total width (mm)	c	1200	1800	2000	1000	550	550	650	650
depth (mm)	d	80	80	80	80	80	80	80	80
electric II (W)		1200	1600	2000	1200	1600	2000	1600	2000

PLANO +

ROOM RADIATOR

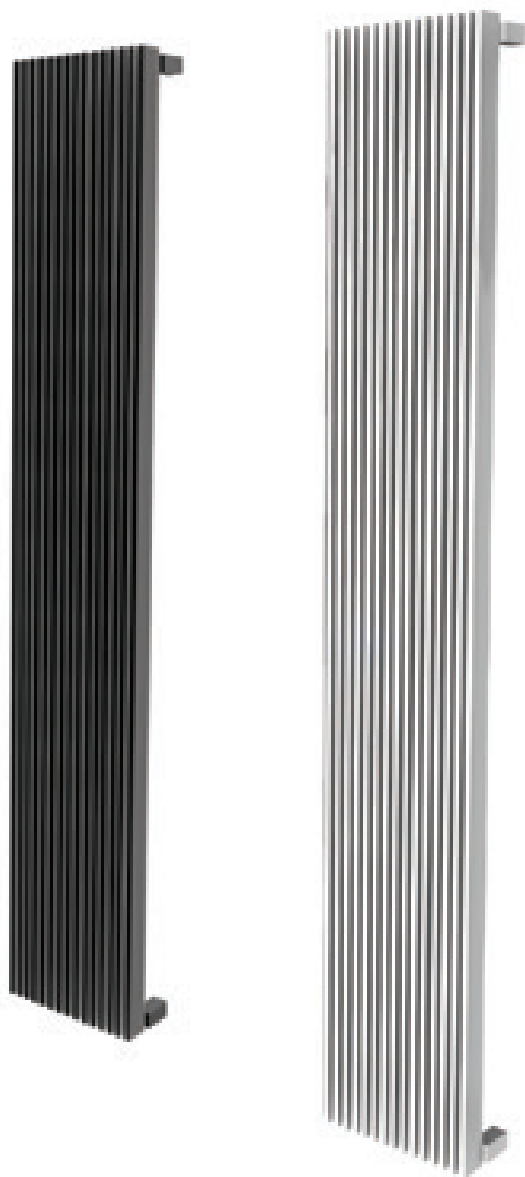

FINISHINGS

- Polished
- Brushed
- Textured Black
- White 9016 Satin
- RAL Colour

VERSION

- Central Heating

MATERIAL

- Stainless Steel
- Steel

option A

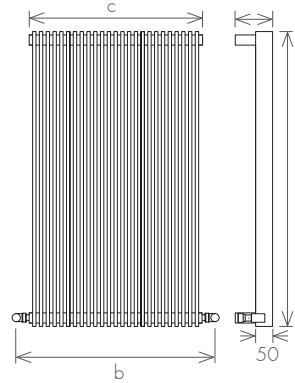

option B

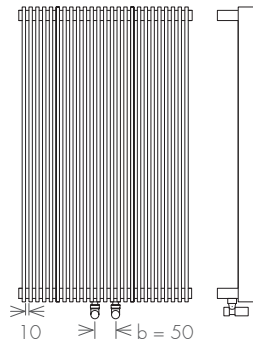

option C

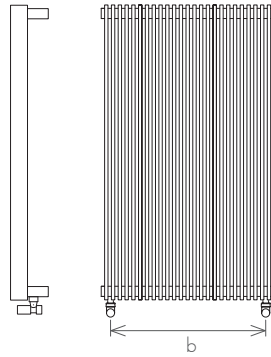

option D

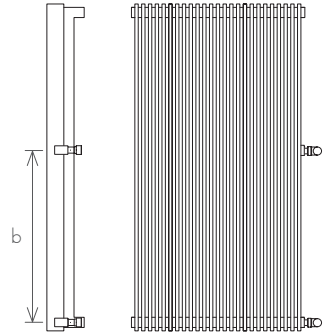

* Different width between axes and positioning of valves according to the client's choice.

model	P+1200 10	P+1400 10	P+1800 10	P+2000 10	P+1200 25	P+1400 25	P+1800 25
no. of elements	10	10	10	10	25	25	25
height (mm) a	1200	1400	1800	2000	1200	1400	1800
total width (mm) c	210	210	210	210	510	510	510
depth (mm) d	120	120	120	120	120	120	120
capacity (l)	4,25	4,91	6,23	6,89	10,61	12,26	15,55
weight (kg)	17,14	19,90	25,42	28,18	42,81	49,71	63,51
central heating (W)	782	901	1136	1256	1960	2259	2845

model	P+2000 25	P+1200 31	P+1400 31	P+1800 31	P+2000 31	P+1200 36	P+1400 36
no. of elements	25	31	31	31	31	36	36
height (mm) a	2000	1200	1400	1800	2000	1200	1400
total width (mm) c	510	630	630	630	630	730	730
depth (mm) d	120	120	120	120	120	120	120
capacity (l)	17,19	13,16	15,20	19,28	21,32	15,28	17,65
weight (kg)	70,41	53,08	61,64	78,75	87,31	61,64	71,57
central heating (W)	3146	2432	2801	3157	3902	2826	3257

model	P+2000 60	P+251200	P+25 1400	P+25 1800	P+31 1200	P+31 1400	P+31 1800
no. of elements	60	25	25	25	31	31	31
height (mm) a	2000	510	510	510	630	630	630
total width (mm) c	1210	1200	1400	1800	1200	1400	1800
depth (mm) d	120	120	120	120	120	120	120
capacity (l)	41,24	10,61	12,26	15,55	13,16	15,20	19,28
weight (kg)	168,95	42,81	49,71	63,51	53,08	61,64	78,75
central heating (W)	7520	1960	2259	2845	2432	2801	3157

option E

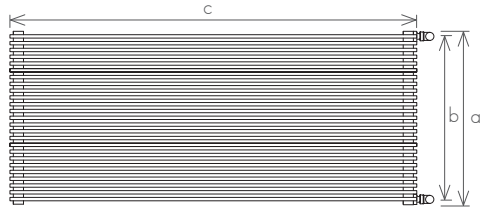

option F

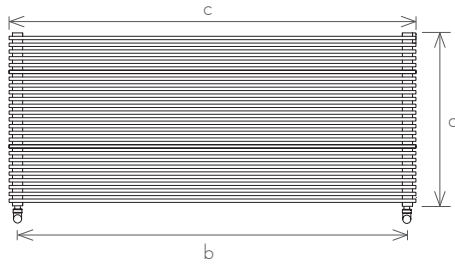

option G

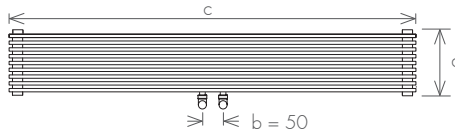

P+1800 36 P+2000 36 P+1200 40 P+1400 40 P+1800 40 P+2000 40 P+1200 60 P+1400 60 P+1800 60

36	36	40	40	40	40	60	60	60
1800	2000	1200	1400	1800	2000	1200	1400	1800
730	730	810	810	810	810	1210	1210	1210
120	120	120	120	120	120	120	120	120
22,38	24,75	16,97	19,60	24,87	27,50	25,45	29,40	37,30
91,45	101,38	68,48	79,52	101,60	112,71	102,71	119,27	152,39
4099	4530	3139	3619	4557	5030	4706	5427	6820

P+36 1200 P+36 1400 P+36 1800 P+40 1200 P+40 1400 P+40 1800 P+60 1200 P+60 1400 P+60 1800

36	36	36	40	40	40	60	60	60
730	730	730	810	810	810	1210	1210	1210
1200	1400	1800	1200	1400	1800	1200	1400	1800
120	120	120	120	120	120	120	120	120
15,28	17,65	22,38	16,97	19,60	24,87	25,45	29,40	37,30
61,64	71,57	91,45	68,48	79,52	101,60	102,71	119,27	152,39
2826	3257	4099	3139	3619	4557	4706	5427	6820

PLANO

ROOM RADIATOR

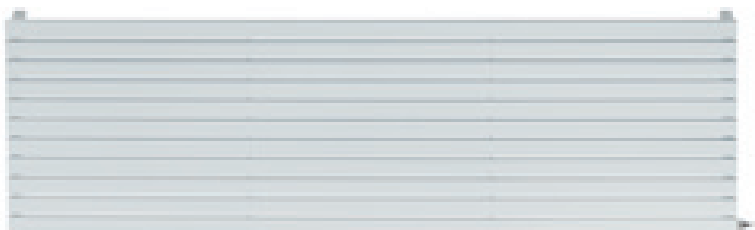

VERSION: ELECTRIC II

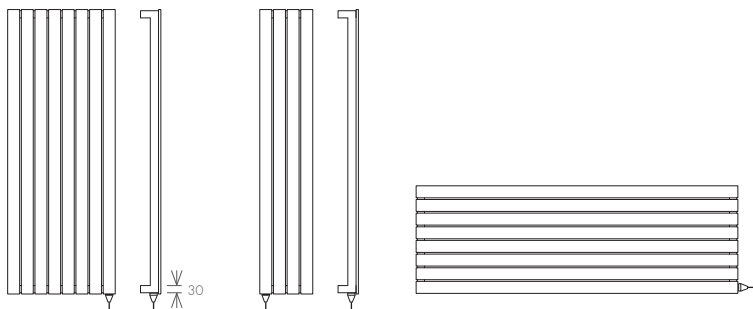

model	P1200 4	P1400 4	P1800 4	P2000 4	P1200 8	P1400 8	P1800 8	P2000 8	P1200 9
no. of elements	4	4	4	4	8	8	8	8	9
height (mm) a	1200	1400	1800	2000	1200	1400	1800	2000	1200
total width (mm) c	221	221	221	221	449	449	449	449	506
depth (mm) d	85	85	85	85	85	85	85	85	85
capacity (l)	2,01	2,29	2,98	3,25	4,10	4,70	5,98	6,32	4,54
weight (kg)	7,24	8,34	10,55	11,65	14,49	16,70	21,12	23,32	16,31
central heating (W)	325	379	469	497	654	733	925	956	713
electric (W)	600	600	600	600	1000	1000	1000	1000	1200

model	P1400 14	P1800 14	P2000 14	P1200 21	P1400 21	P1800 21	P2000 21	P9 1200	P9 1400
no. of elements	14	14	14	21	21	21	21	9	9
height (mm) a	1400	1800	2000	1200	1400	1800	2000	506	506
total width (mm) c	791	791	791	1190	1190	1190	1190	1200	1400
depth (mm) d	85	85	85	85	85	85	85	85	85
capacity (l)	7,60	9,44	10,37	10,03	11,41	14,17	15,55	4,54	5,30
weight (kg)	29,24	36,97	40,83	38,07	43,87	55,46	62,55	16,31	18,79
central heating (W)	1276	1594	1603	1649	1899	2390	2641	713	829
electric (W)	2000	2000	2000	2000	2000	2000	2000	1200	1200

option A

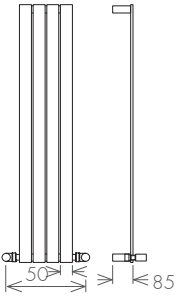

option B

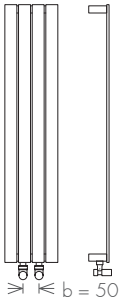

option C

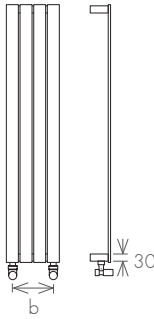

option D

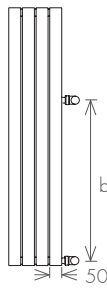

option E

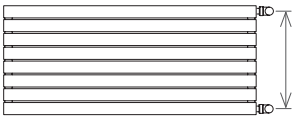

option G

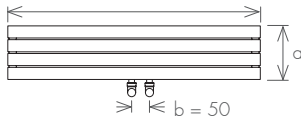

option F

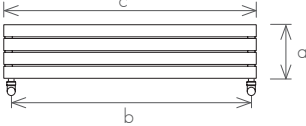

* Different width between axles and positioning of valves according to the client's choice.

P1400 9	P1800 9	P2000 9	P120010	P140010	P180010	P200010	P1200 11	P1400 11	P1800 11	P2000 11	P1200 14
9	9	9	10	10	10	10	11	11	11	11	14
1400	1800	2000	1200	1400	1800	2000	1200	1400	1800	2000	1200
506	506	506	563	563	563	563	620	620	620	620	791
85	85	85	85	85	85	85	85	85	85	85	85
5,30	6,69	7,21	5,11	5,97	7,44	8,10	5,71	6,51	8,26	8,74	6,68
18,79	23,76	26,24	18,12	20,88	26,40	29,16	19,93	22,97	29,04	32,08	25,38
829	1022	1117	814	933	1142	1263	864	997	1262	1388	1106
1600	2000	2000	1200	1200	2000	2000	1600	2000	2000	2000	2000

P9 1800	P10 1200	P10 1400	P10 1800	P11 1200	P11 1400	P11 1800	P14 1200	P14 1400	P14 1800	P21 1200	P21 1400
9	10	10	10	11	11	11	14	14	14	21	21
506	563	563	563	620	620	620	791	791	791	1190	1190
1800	1200	1400	1800	1200	1400	1800	1200	1400	1800	1200	1400
85	85	85	85	85	85	85	85	85	85	85	85
6,69	5,11	5,97	7,44	5,71	6,51	8,26	6,68	7,60	9,44	10,03	11,41
23,76	18,12	20,88	26,40	19,93	22,97	29,04	25,38	29,24	36,97	38,07	43,87
1002	814	933	1142	864	997	1262	1106	1276	1594	1649	1899
1200	1200	1200	1200	1200	1600	2000	1600	1600	2000	1600	2000

DOMOTIC TOUCH

TECHNOLOGY

The Domotic Touch is a simple control solution with the installation parameters of a normal switch.

Economical functionality

Increases the energetic efficiency with the setup of working hours (one, two or three hours).

Comfort functionality

Control of the energy expenditure through the temperature setup (18°C, 20°C, 22°C, 24°C). Equipped with a room temperature sensor that allows the selection of the desired temperature for the comfort of the space.

Flexibility

The Domotic Touch allows the management of one or more radiators or towel warmers in the same space.

Duty-cycle

Function to use for a more customized control equipment temperature.

The activation of this mode is shown by the light indicator above the icon.

Operation timed at 25%, 50%, 75% and 100% per 20 minute period.

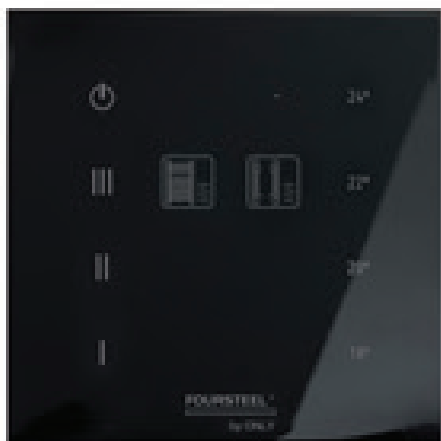

BLACK GLASS



WHITE GLASS

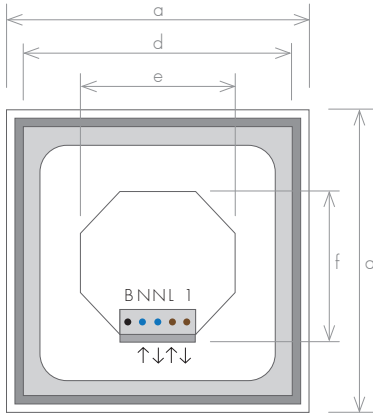

model	DT
total measure exterior (mm) a	90 x 90
exterior depth (mm) b	5
interior case depth (mm) c	40
total measure interior (mm) d	73 x 73
horizontal back measure (mm) e	55
vertical back measure (mm) f	51
-	B
neutral input	N
neutral output towel warmer/ radiator	N
phase input	L
phase output towel warmer/ radiator	1



MATTE WHITE



MATTE BLACK



SWITCH ON OFF

Ø60MM X 70MM | IP54

CLASS 2

110V - 230V



PVD BRUSHED GOLD

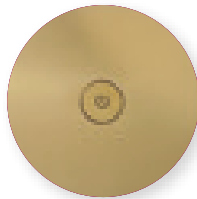

PVD POLISHED GOLD



BRUSHED



POLISHED

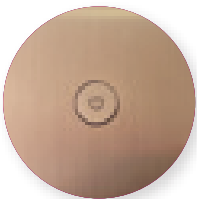

PVD BRUSHED COPPER

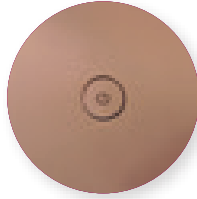

PVD POLISHED COPPER

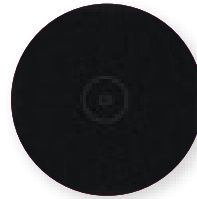

TEXTURED BLACK



WHITE 9016 SATIN

SWITCH ON OFF



Ø60MM X 70MM | IP54

CLASS 2

110V - 230V

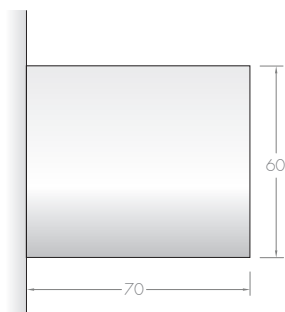
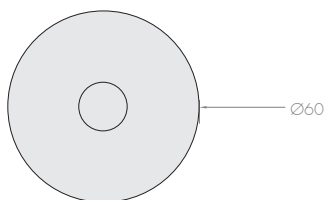



MIMOO SWITCH

80MM X 80MM X 6MM | IP54

CLASS 2

110V - 230V



PVD BRUSHED GOLD



PVD POLISHED GOLD



BRUSHED



POLISHED



PVD BRUSHED COPPER

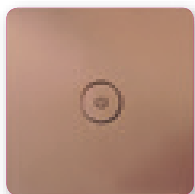

PVD POLISHED COPPER



TEXTURED BLACK



WHITE 9016 SATIN



MIMOO SWITCH ROUND

85MM X 6MM | IP54

CLASS 2

110V - 230V

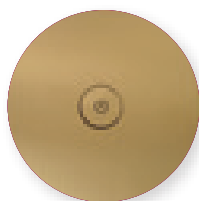

PVD BRUSHED GOLD



PVD POLISHED GOLD



BRUSHED



POLISHED

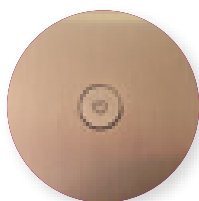

PVD BRUSHED COPPER

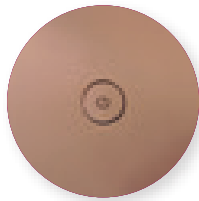

PVD POLISHED COPPER



TEXTURED BLACK



WHITE 9016 SATIN

MIMOO SWITCH

MIMOO SWITCH



80MM X 80MM X 6MM | IP54
CLASS 2
110V - 230V

SIDE VIEW

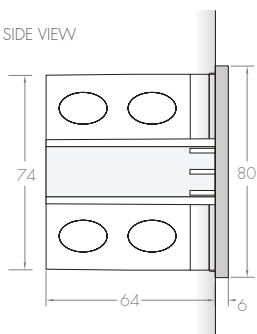

FRONT VIEW

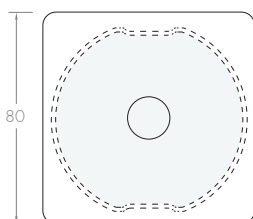

MIMOO SWITCH ROUND



Ø85MM X 6MM | IP54
CLASS 2
110V - 230V

SIDE VIEW

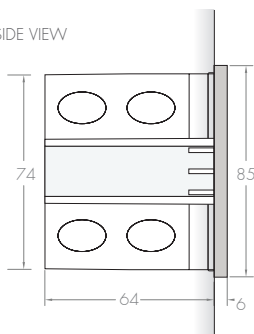

FRONT VIEW

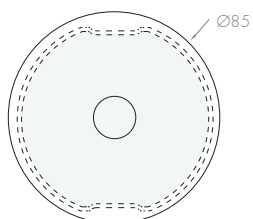

ELECTRIC ELEMENTS

ELECTRIC ELEMENT I
only available in Portugal



CLASS 1 | IP X4
VERTICAL ALIGNMENT
ON/OFF
TEMPERATURE CONTROL

ELECTRIC ELEMENT II



CLASS 2 | IP 64
VERTICAL ALIGNMENT
HORIZONTAL ALIGNMENT

ELECTRIC ELEMENT III
only available in Portugal

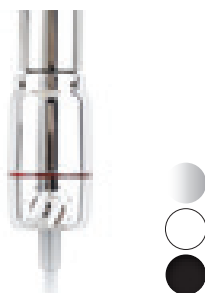

CLASS 1 | IP 65
VERTICAL ALIGNMENT
ON/OFF
TEMPERATURE CONTROL

ELECTRIC ELEMENT IV



CLASS 2 | IP 65
VERTICAL ALIGNMENT
HORIZONTAL ALIGNMENT
ON/OFF
TEMPERATURE CONTROL
TIMER 2H
ROOM TEMPERATURE SENSOR

ELECTRIC ELEMENT V



CLASS 2 | IP X4
VERTICAL ALIGNMENT
ON/OFF
TEMPERATURE CONTROL
TIMER 2H
ROOM TEMPERATURE SENSOR

ELECTRIC ELEMENT VI



CLASS 2 | IP X4
VERTICAL ALIGNMENT
ON/OFF
TEMPERATURE CONTROL
TIMER 2H
ROOM TEMPERATURE SENSOR
PROGRAMMABLE

VALVES AND RETAINERS

VALVE KIT 1

Square manual angled valve and retainer

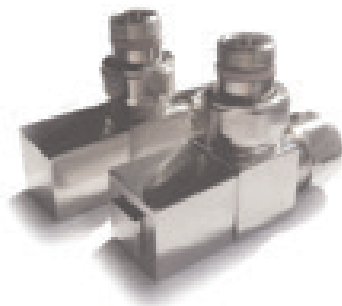
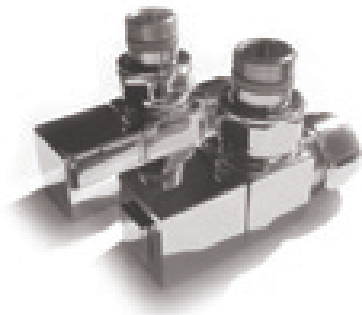

VALVE KIT 2

Square manual angled valve and retainer



VALVE KIT 3

Round manual angled valve and retainer

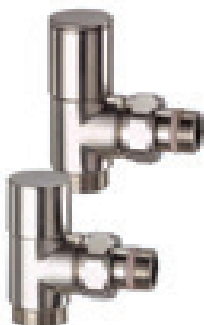

VALVE KIT 4

Round manual angled valve and retainer

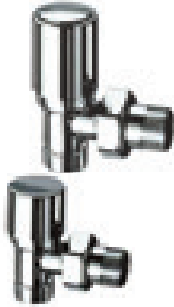

VALVE KIT 5

Rewind manual valve

french style

english style

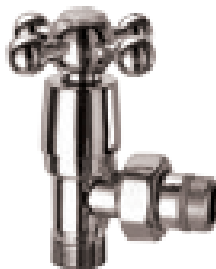

VALVE KIT 6

Manual valve and retainer

Manual valve and retainer

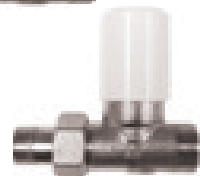
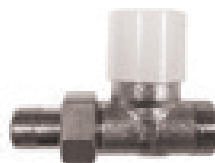
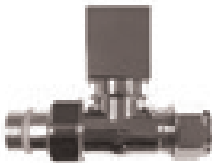

VALVE KIT 7

Round manual angled valve and retainer



THERMOSTATIC KIT 1

Thermostatic head + Cover

Thermostatic valve

Retainer

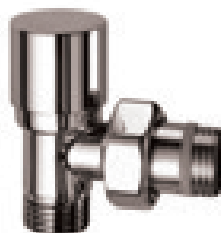

THERMOSTATIC KIT 2

Valve with thermostatic head

Retainer

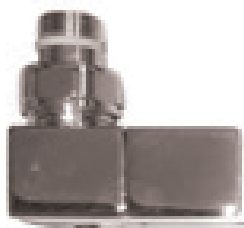
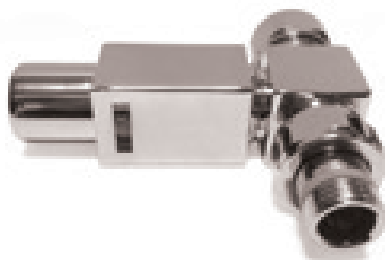

THERMOSTATIC KIT 3

Thermostatic valve



Thermostatic valve



Retainer



WALL VALVE KIT 1

Thermostatic valves

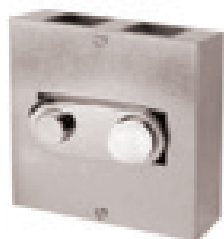

SUPPORTS

Support I



Support II

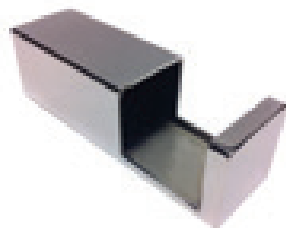

MIXED ADAPTER I

Adapter for mixed version



MIXED ADAPTER II

Adapter for mixed version

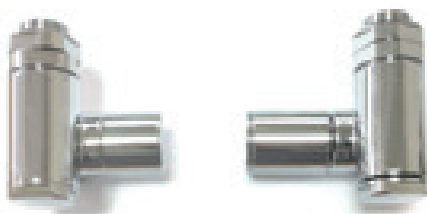

AIR VENT

Air vent 1/2"

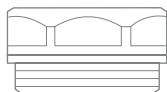

Air vent 1/8"

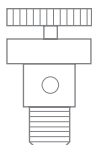

IMPORTANT NOTES:

1. When the position of the electric element is not identified It will always be placed in the lower right side;
2. All our electric heaters consist of electric heater cartridge (heater bar) and thermal fluid.
3. Foursteel® reserves the right to change all the products and related drawings featured in this catalogue without any prior notice.
4. All Foursteel® products are adaptable in terms of size and capacity.

RAL COLORS: color subject to confirmation.

WHITE: RAL 9016 (Standard version)

Certification of electrical products, according to the standards:

IECEN 60335-2-43:

IEC 60335-1:2010 + COR1: 2010 + COR2:2011 + A1:2013 EN 60335-1:2012 + AC:2014 + A11:2014

IEC 60335-2-43:2002 + A1:2005 + A2:2008 EN 60335-2-43:2003 + A1:2006 + A2:2008

Certification of central heating products, according to the standard UN:

EN442 - 2

UL Certification:

UL 499 - Electric Heating Appliances

E506585



